

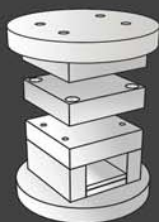

K

Standards Parts





095 X 095

Standards Parts K

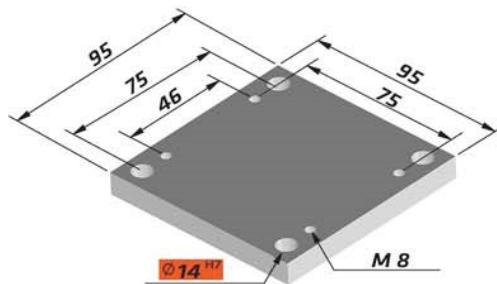

K10

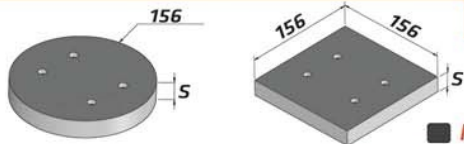

■ K10 C

K 10 / 095 X 095 / S / ST37 / 7225 / 2312 / 2344

22 ■ ●

K11

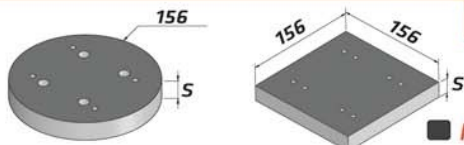

■ K10 C

K 11 / 095 X 095 / S / ST37 / 7225 / 2312 / 2344

22 ■ ●

K20

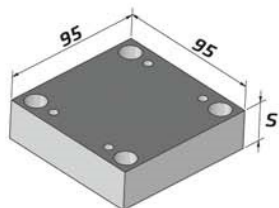

K 20 / 095 X 095 / S / ST37 / 7225 / 2312 / 2344

22	■	■
27	■	■
37	■	■
46	■	■
56	■	■

K30

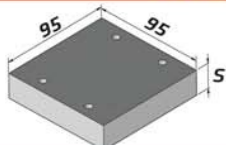

K 30 / 095 X 095 / S / ST37 / 7225 / 2312 / 2344

17 ■
22 ■

K40

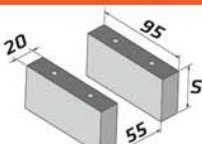

K 40 / 095 X 095 / S / ST37 / 7225 / 2312 / 2344

46 ■
56 ■
76

K60

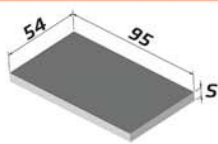

K 60 / 095 X 095 / S / ST37 / 7225 / 2312 / 2344

6 ■

K70

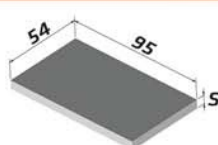

K 70 / 095 X 095 / S / ST37 / 7225 / 2312 / 2344

9 ■

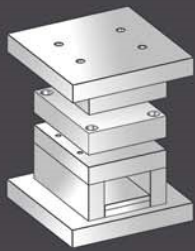

100 X 130

Standards Parts K

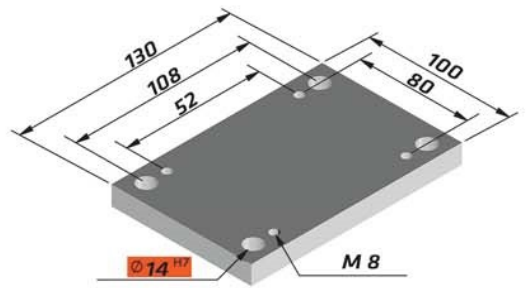

K10

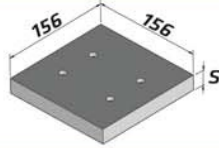

K 10 / 100 X 130 / S / ST37 / 7225 / 2312 / 2344

22 ■

K11

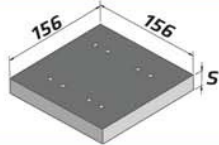

K 11 / 100 X 130 / S / ST37 / 7225 / 2312 / 2344

22 ■

K20

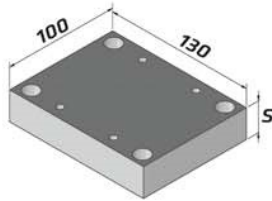
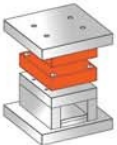

K 20 / 100 X 130 / S / ST37 / 7225 / 2312 / 2344

22	■	■
37	■	■
46	■	■
56	■	■
66		
76		
86		

K30

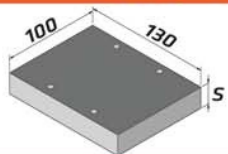
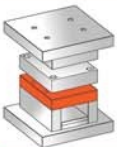

K 30 / 100 X 130 / S / ST37 / 7225 / 2312 / 2344

17 ■
22 ■

K40

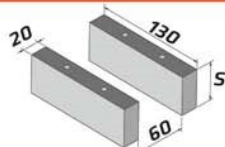
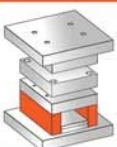

K 40 / 100 X 130 / S / ST37 / 7225 / 2312 / 2344

46 ■
56 ■
76

K60

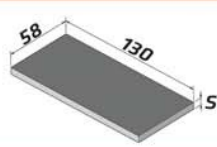
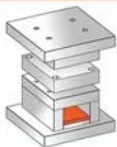

K 60 / 100 X 130 / S / ST37 / 7225 / 2312 / 2344

6 ■

K70

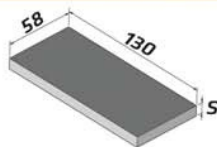
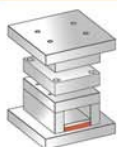

K 70 / 100 X 130 / S / ST37 / 7225 / 2312 / 2344

9 ■

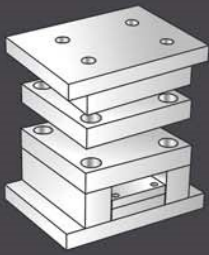

120 X 120

Standards Parts K

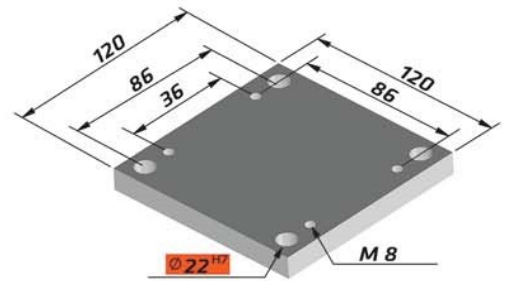

K10 / 120 X 120 / S / ST37 / 7225 / 2312 / 2344

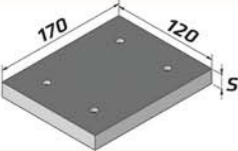
22	■
----	---

K11 / 120 X 120 / S / ST37 / 7225 / 2312 / 2344

22	■
----	---

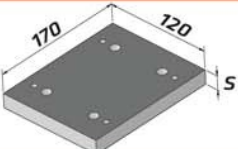
K20 / 120 X 120 / S / ST37 / 7225 / 2312 / 2344

27	■	■
37	■	■
46	■	■
56	■	■
66	■	■
76	■	■
86		

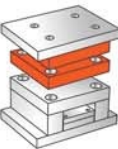
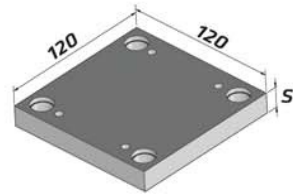
K30 / 120 X 120 / S / ST37 / 7225 / 2312 / 2344

27	■
----	---

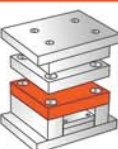
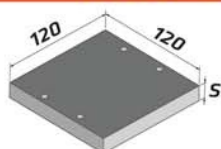
K40 / 120 X 120 / S / ST37 / 7225 / 2312 / 2344

46	■
56	■
76	

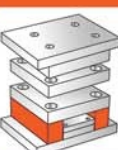
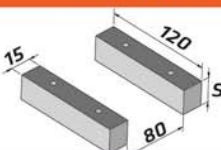
K60 / 120 X 120 / S / ST37 / 7225 / 2312 / 2344



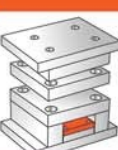
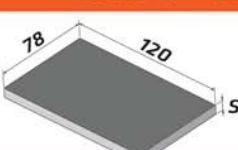

12	■
----	---

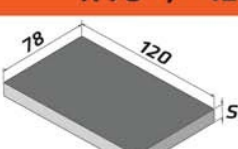
K70 / 120 X 120 / S / ST37 / 7225 / 2312 / 2344



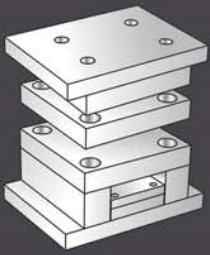

17	■
----	---

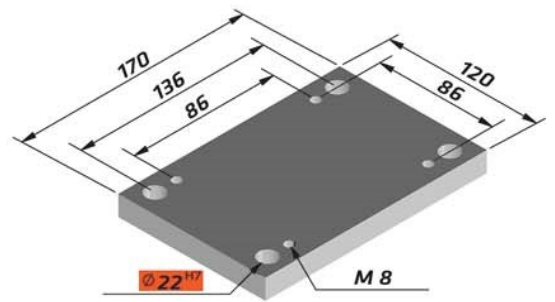

120 X 170

Standards Parts K



K10			K 10 / 120 X 170 / S / ST37 / 7225 / 2312 / 2344		
			22	■	

K11			K 11 / 120 X 170 / S / ST37 / 7225 / 2312 / 2344		
			22	■	

K20			K 20 / 120 X 170 / S / ST37 / 7225 / 2312 / 2344		
			27	■	■
			37	■	■
			46	■	■
			56	■	■
			66	■	■
			76		
86					

K30			K 30 / 120 X 170 / S / ST37 / 7225 / 2312 / 2344		
			27	■	

K40			K 40 / 120 X 170 / S / ST37 / 7225 / 2312 / 2344		
			46	■	
			56	■	
			76		

K60			K 60 / 120 X 170 / S / ST37 / 7225 / 2312 / 2344		
			12	■	

K70			K 70 / 120 X 170 / S / ST37 / 7225 / 2312 / 2344		
			17	■	

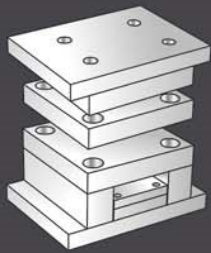

156 X 156

Standards Parts K

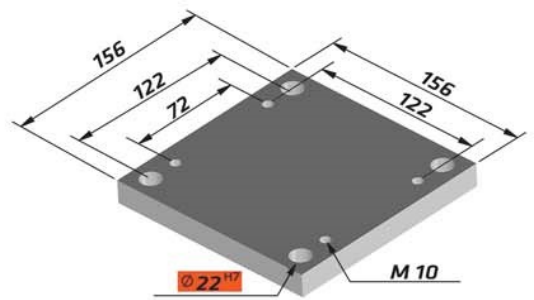

K10

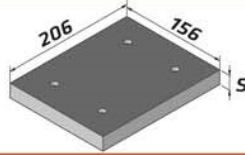

K 10 / 156 X 156 / S / ST37 / 7225 / 2312 / 2344

22 ■

27

K11

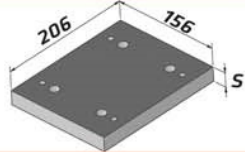

K 11 / 156 X 156 / S / ST37 / 7225 / 2312 / 2344

22 ■

27

K20

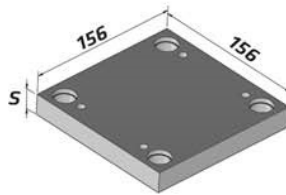
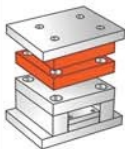

K 20 / 156 X 156 / S / ST37 / 7225 / 2312 / 2344

27



37



46



56



66



76

86

K30

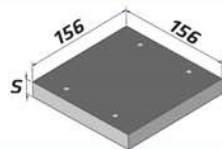
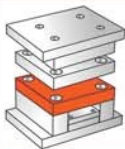

K 30 / 156 X 156 / S / ST37 / 7225 / 2312 / 2344

27 ■

37

K40

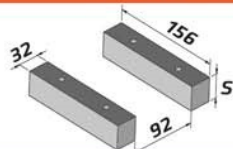

K 40 / 156 X 156 / S / ST37 / 7225 / 2312 / 2344

46 ■

56 ■

76

96

K60

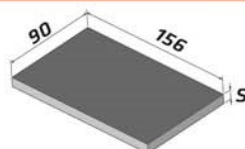
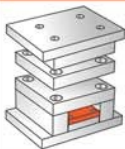

K 60 / 156 X 156 / S / ST37 / 7225 / 2312 / 2344

12 ■

K70

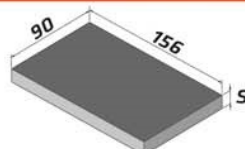
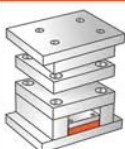

K 70 / 156 X 156 / S / ST37 / 7225 / 2312 / 2344

17 ■

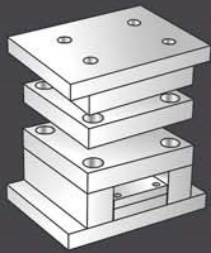

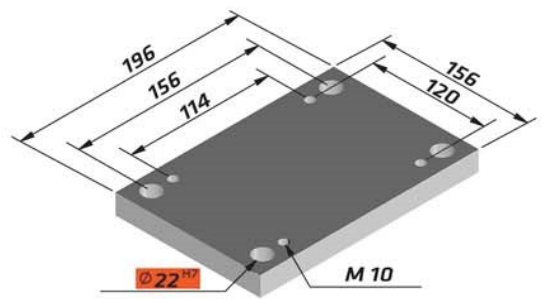

156 X 196

Standards Parts K

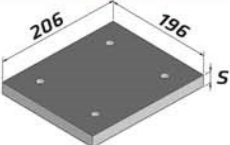

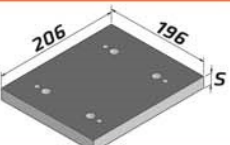
K10	K 10 / 156 X 196 / S / ST37 / 7225 / 2312 / 2344			
			22	■
		27		

K11	K 11 / 156 X 196 / S / ST37 / 7225 / 2312 / 2344			
			22	■
		27		

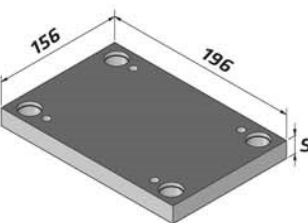
K20	K 20 / 156 X 196 / S / ST37 / 7225 / 2312 / 2344				
			27	■	■
			37	■	■
			46	■	■
			56	■	■
			66	■	■
			76		
			86		

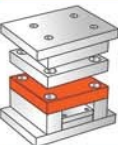
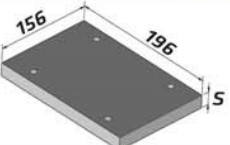
K30	K 30 / 156 X 196 / S / ST37 / 7225 / 2312 / 2344			
			27	■
		37		

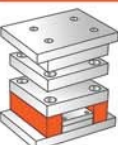
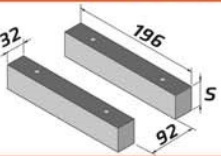
K40	K 40 / 156 X 196 / S / ST37 / 7225 / 2312 / 2344				
			46	■	
			56	■	
			76		
		96			

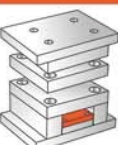
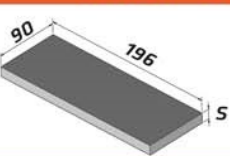
K60	K 60 / 156 X 196 / S / ST37 / 7225 / 2312 / 2344			
			12	■

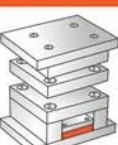
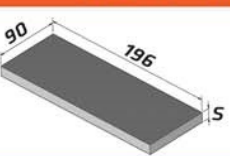
K70	K 70 / 156 X 196 / S / ST37 / 7225 / 2312 / 2344			
			17	■

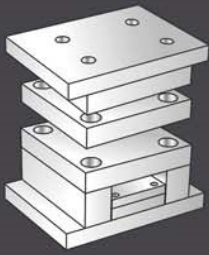

156 X 246

Standards Parts K

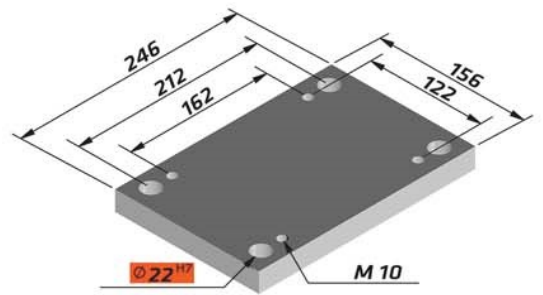

K10 / 156 X 246 / S / ST37 / 7225 / 2312 / 2344

22	■
27	

K11 / 156 X 246 / S / ST37 / 7225 / 2312 / 2344

22	■
27	

K20 / 156 X 246 / S / ST37 / 7225 / 2312 / 2344

27	■	■
37	■	■
46	■	■
56	■	■
66	■	■
76		
86		

K30 / 156 X 246 / S / ST37 / 7225 / 2312 / 2344

27	■
37	

K40 / 156 X 246 / S / ST37 / 7225 / 2312 / 2344

46	■
56	■
76	
96	

K60 / 156 X 246 / S / ST37 / 7225 / 2312 / 2344

12	■
----	---

K70 / 156 X 246 / S / ST37 / 7225 / 2312 / 2344

17	■
----	---

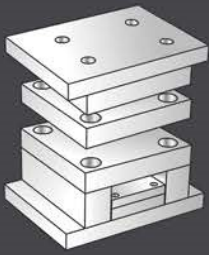

156 X 296

Standards Parts K

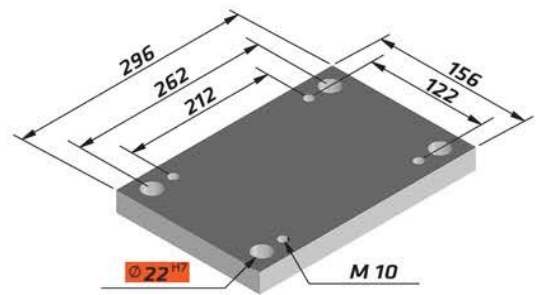

K10			K 10 / 156 X 296 / S / ST37 / 7225 / 2312 / 2344			
			27	■		

K11			K 11 / 156 X 296 / S / ST37 / 7225 / 2312 / 2344			
			27	■		

K20			K 20 / 156 X 296 / S / ST37 / 7225 / 2312 / 2344			
			27	■	■	
			37	■	■	
			46	■	■	
			56	■	■	
			66	■	■	
			76			
86						

K30			K 30 / 156 X 296 / S / ST37 / 7225 / 2312 / 2344			
			27	■		
			37			

K40			K 40 / 156 X 296 / S / ST37 / 7225 / 2312 / 2344			
			46	■		
			56	■		
			76			
96						

K60			K 60 / 156 X 296 / S / ST37 / 7225 / 2312 / 2344			
			12	■		

K70			K 70 / 156 X 296 / S / ST37 / 7225 / 2312 / 2344			
			17	■		

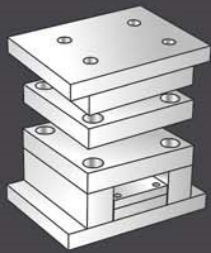

170 X 170

Standards Parts K

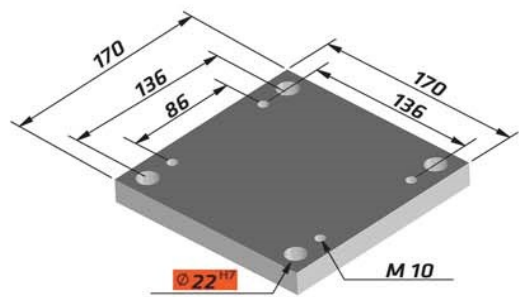

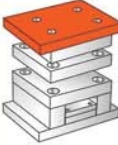
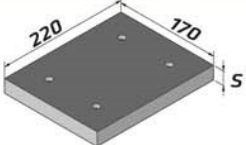
K10	K 10 / 170 X 170 / S / ST37 / 7225 / 2312 / 2344			
			22	■
		27		

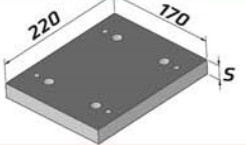
K11	K 11 / 170 X 170 / S / ST37 / 7225 / 2312 / 2344			
			22	■
		27		

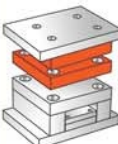
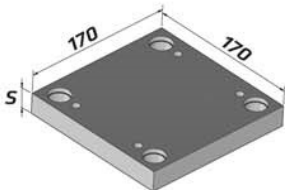
K20	K 20 / 170 X 170 / S / ST37 / 7225 / 2312 / 2344				
			27	■	■
			37	■	■
			46	■	■
			56	■	■
			66	■	■
			76		
86					

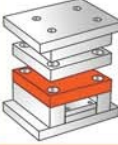
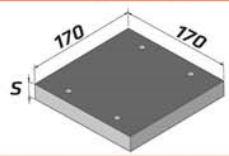
K30	K 30 / 170 X 170 / S / ST37 / 7225 / 2312 / 2344			
			27	■
37				

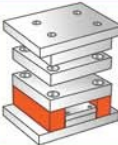
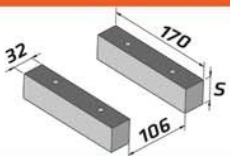
K40	K 40 / 170 X 170 / S / ST37 / 7225 / 2312 / 2344				
			46	■	
			56	■	
			76		
96					

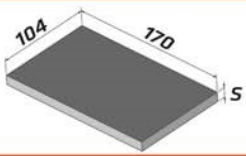
K60	K 60 / 170 X 170 / S / ST37 / 7225 / 2312 / 2344			
			12	■

K70	K 70 / 170 X 170 / S / ST37 / 7225 / 2312 / 2344			
			17	■

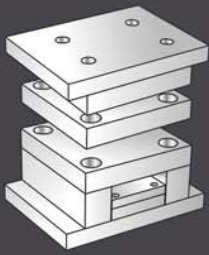

190 X 246

Standards Parts K

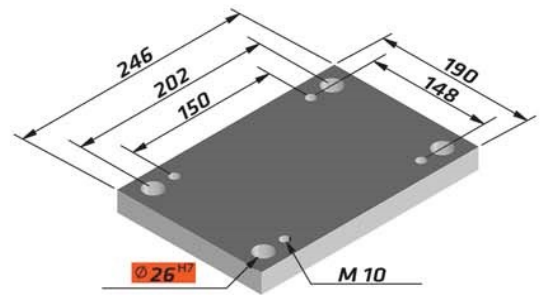

K10 / 190 X 246 / S / ST37 / 7225 / 2312 / 2344

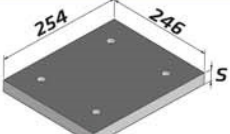
22	■
27	

K11 / 190 X 246 / S / ST37 / 7225 / 2312 / 2344

22	■
27	

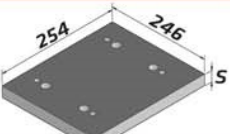
K20 / 190 X 246 / S / ST37 / 7225 / 2312 / 2344

27	■	■
37	■	■
46	■	■
56	■	■
66	■	■
76		
86		

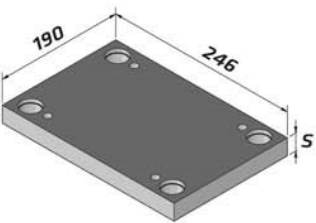
K30 / 190 X 246 / S / ST37 / 7225 / 2312 / 2344

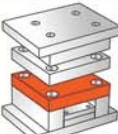
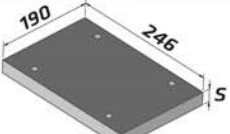

27	■
37	

K40 / 190 X 246 / S / ST37 / 7225 / 2312 / 2344

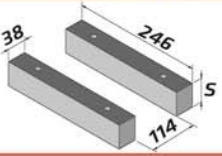

46	■
56	■
76	
96	

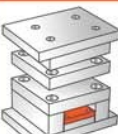
K60 / 190 X 246 / S / ST37 / 7225 / 2312 / 2344



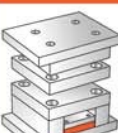

12	■
----	---

K70 / 190 X 246 / S / ST37 / 7225 / 2312 / 2344



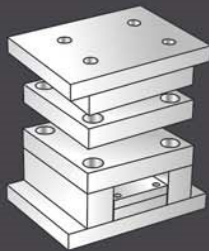

17	■
----	---

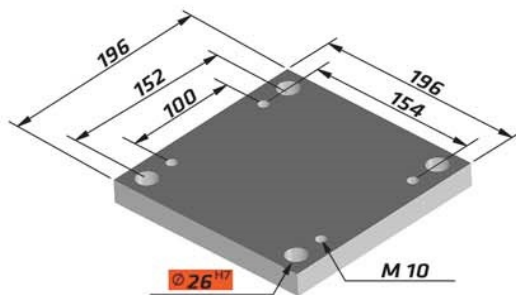

196 X 196

Standards Parts K

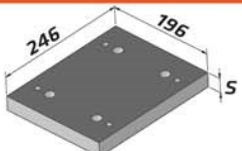

K10			K 10 / 196 X 196 / S / ST37 / 7225 / 2312 / 2344			
			22	■		
27						

K11			K 11 / 196 X 196 / S / ST37 / 7225 / 2312 / 2344			
			22	■		
27						

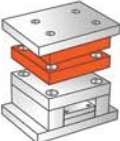
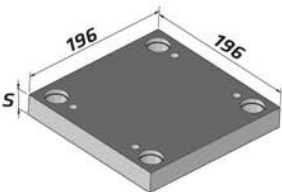
K20			K 20 / 196 X 196 / S / ST37 / 7225 / 2312 / 2344			
			27	■	■	
			37	■	■	
			46	■	■	
			56	■	■	
			66	■	■	
			76			
86						

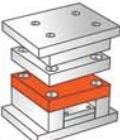
K30			K 30 / 196 X 196 / S / ST37 / 7225 / 2312 / 2344			
			27	■		
37						

K40			K 40 / 196 X 196 / S / ST37 / 7225 / 2312 / 2344			
			46	■		
			56	■		
			76			
96						

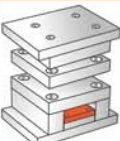
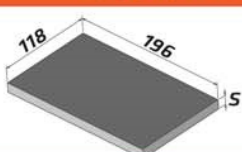
K60			K 60 / 196 X 196 / S / ST37 / 7225 / 2312 / 2344			
			12	■		

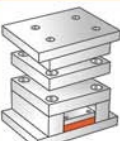
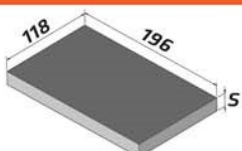
K70			K 70 / 196 X 196 / S / ST37 / 7225 / 2312 / 2344			
			17	■		

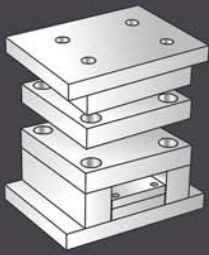

196 X 296

Standards Parts K

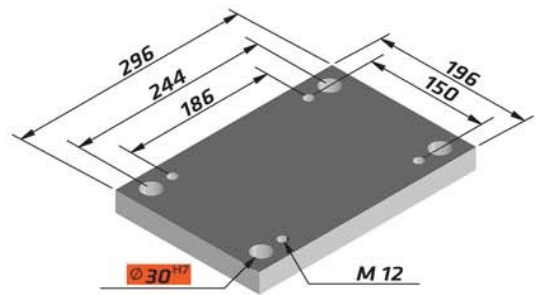

K10 / 196 X 296 / S / ST37 / 7225 / 2312 / 2344

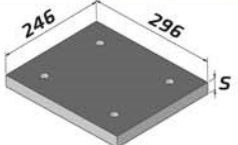
27	■
37	

K11 / 196 X 296 / S / ST37 / 7225 / 2312 / 2344

27	■
37	

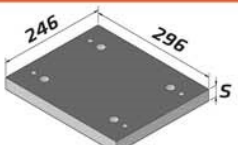
K20 / 196 X 296 / S / ST37 / 7225 / 2312 / 2344

27	■	■
37	■	■
46	■	■
56	■	■
66	■	■
76		
86		

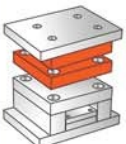
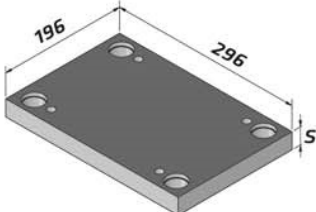
K30 / 196 X 296 / S / ST37 / 7225 / 2312 / 2344

27	■
37	

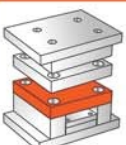
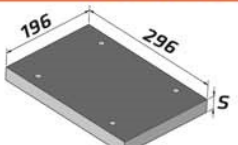
K40 / 196 X 296 / S / ST37 / 7225 / 2312 / 2344

46	■
56	■
76	
96	

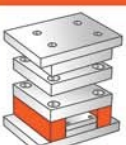
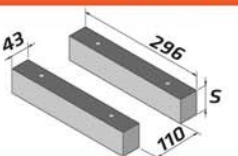
K60 / 196 X 296 / S / ST37 / 7225 / 2312 / 2344



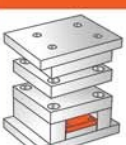
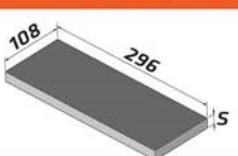

12	■
----	---

K70 / 196 X 296 / S / ST37 / 7225 / 2312 / 2344



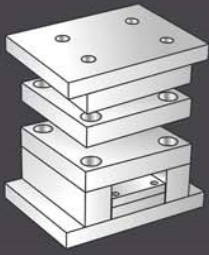

17	■
----	---

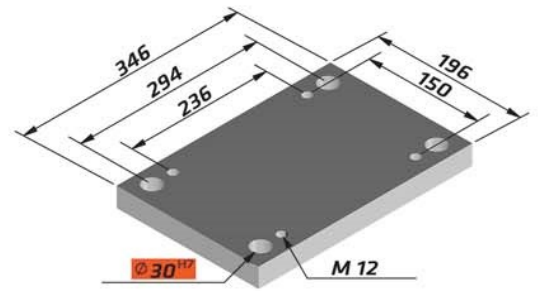

196 X 346

Standards Parts K



K10 / 196 X 346 / S / ST37 / 7225 / 2312 / 2344	
K10	27 <input type="checkbox"/>
	37 <input type="checkbox"/>

K11 / 196 X 346 / S / ST37 / 7225 / 2312 / 2344	
K11	27 <input type="checkbox"/>
	37 <input type="checkbox"/>

K20 / 196 X 346 / S / ST37 / 7225 / 2312 / 2344	
K20	27 <input type="checkbox"/> <input type="checkbox"/>
	37 <input type="checkbox"/> <input type="checkbox"/>
	46 <input type="checkbox"/> <input type="checkbox"/>
	56 <input type="checkbox"/> <input type="checkbox"/>
	66 <input type="checkbox"/> <input type="checkbox"/>
	76 <input type="checkbox"/>
	86 <input type="checkbox"/>

K30 / 196 X 346 / S / ST37 / 7225 / 2312 / 2344	
K30	27 <input type="checkbox"/>
	37 <input type="checkbox"/>

K40 / 196 X 346 / S / ST37 / 7225 / 2312 / 2344	
K40	46 <input type="checkbox"/>
	56 <input type="checkbox"/>
	76 <input type="checkbox"/>
	96 <input type="checkbox"/>

K60 / 196 X 346 / S / ST37 / 7225 / 2312 / 2344	
K60	12 <input type="checkbox"/>

K70 / 196 X 346 / S / ST37 / 7225 / 2312 / 2344	
K70	17 <input type="checkbox"/>

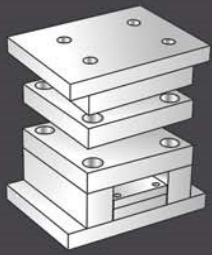

196 X 396

Standards Parts K

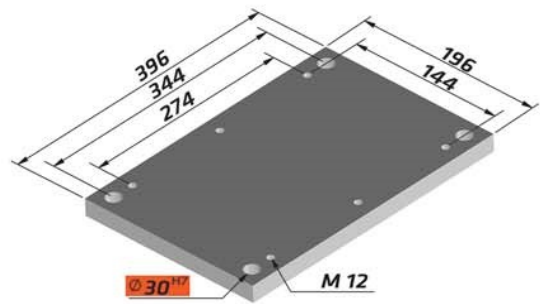

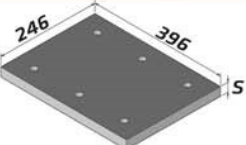
K10			K 10 / 196 X 396 / S / ST37 / 7225 / 2312 / 2344		
			27	■	
			37		

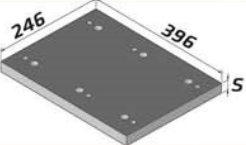
K11			K 11 / 196 X 396 / S / ST37 / 7225 / 2312 / 2344		
			27	■	
			37		

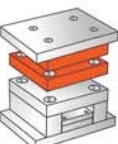
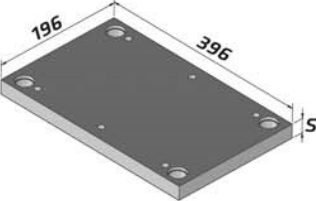
K20			K 20 / 196 X 396 / S / ST37 / 7225 / 2312 / 2344		
			27	■	■
			37	■	■
			46	■	■
			56	■	■
			66	■	■
			76		
86					

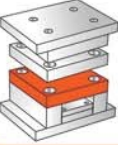
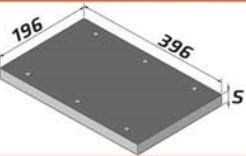
K30			K 30 / 196 X 396 / S / ST37 / 7225 / 2312 / 2344		
			27	■	
			37		

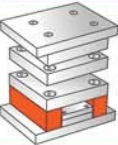
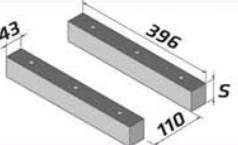
K40			K 40 / 196 X 396 / S / ST37 / 7225 / 2312 / 2344		
			56	■	
			76	■	
			96		

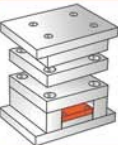
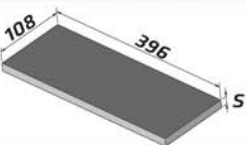
K60			K 60 / 196 X 396 / S / ST37 / 7225 / 2312 / 2344		
			17	■	

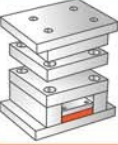
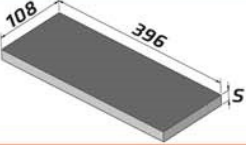
K70			K 70 / 196 X 396 / S / ST37 / 7225 / 2312 / 2344		
			22	■	

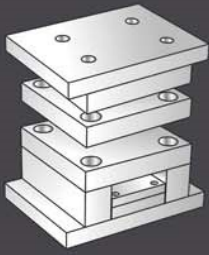

196 X 446

Standards Parts K

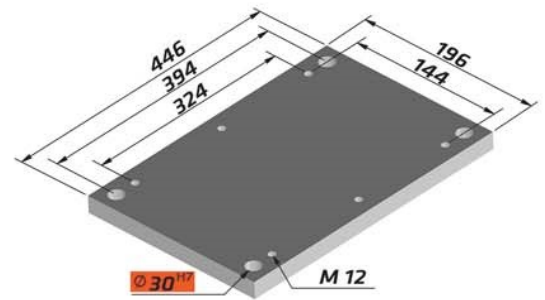

K10	K 10 / 196 X 446 / S / ST37 / 7225 / 2312 / 2344			
			27	■
		37		

K11	K 11 / 196 X 446 / S / ST37 / 7225 / 2312 / 2344			
			27	■
		37		

K20	K 20 / 196 X 446 / S / ST37 / 7225 / 2312 / 2344				
			27	■	■
			37	■	■
			46	■	■
			56	■	■
			66	■	■
			76		
86					

K30	K 30 / 196 X 446 / S / ST37 / 7225 / 2312 / 2344			
			27	■
		37		

K40	K 40 / 196 X 446 / S / ST37 / 7225 / 2312 / 2344				
			56	■	
			76	■	
96					

K60	K 60 / 196 X 446 / S / ST37 / 7225 / 2312 / 2344			
			17	■

K70	K 70 / 196 X 446 / S / ST37 / 7225 / 2312 / 2344			
			22	■

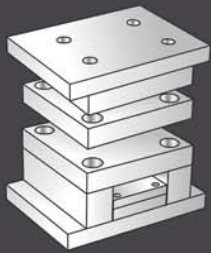

196 X 496

Standards Parts K

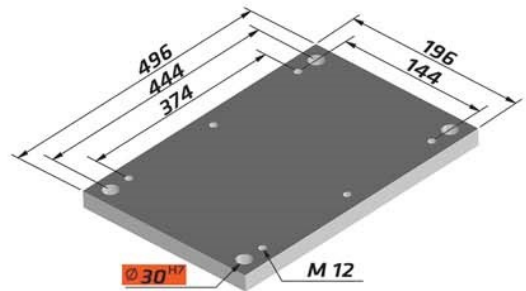

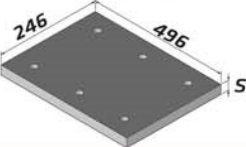
K10 / 196 X 496 / S / ST37 / 7225 / 2312 / 2344						
K10	 	<table border="1"> <tr> <td>27</td> <td>■</td> </tr> <tr> <td>37</td> <td></td> </tr> </table>	27	■	37	
	27	■				
37						

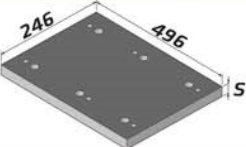
K11 / 196 X 496 / S / ST37 / 7225 / 2312 / 2344						
K11	 	<table border="1"> <tr> <td>27</td> <td>■</td> </tr> <tr> <td>37</td> <td></td> </tr> </table>	27	■	37	
	27	■				
37						

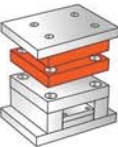
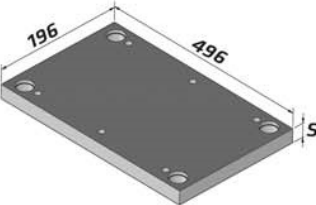
K20 / 196 X 496 / S / ST37 / 7225 / 2312 / 2344																							
K20	 	<table border="1"> <tr> <td>27</td> <td>■</td> <td>■</td> </tr> <tr> <td>37</td> <td>■</td> <td>■</td> </tr> <tr> <td>46</td> <td>■</td> <td>■</td> </tr> <tr> <td>56</td> <td>■</td> <td>■</td> </tr> <tr> <td>66</td> <td>■</td> <td>■</td> </tr> <tr> <td>76</td> <td></td> <td></td> </tr> <tr> <td>86</td> <td></td> <td></td> </tr> </table>	27	■	■	37	■	■	46	■	■	56	■	■	66	■	■	76			86		
		27	■	■																			
		37	■	■																			
		46	■	■																			
		56	■	■																			
		66	■	■																			
76																							
86																							

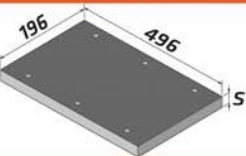
K30 / 196 X 496 / S / ST37 / 7225 / 2312 / 2344						
K30	 	<table border="1"> <tr> <td>27</td> <td>■</td> </tr> <tr> <td>37</td> <td></td> </tr> </table>	27	■	37	
	27	■				
37						

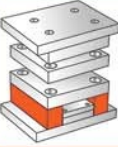
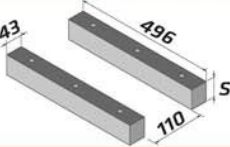
K40 / 196 X 496 / S / ST37 / 7225 / 2312 / 2344								
K40	 	<table border="1"> <tr> <td>56</td> <td>■</td> </tr> <tr> <td>76</td> <td>■</td> </tr> <tr> <td>96</td> <td></td> </tr> </table>	56	■	76	■	96	
	56	■						
	76	■						
96								

K60 / 196 X 496 / S / ST37 / 7225 / 2312 / 2344				
K60	 	<table border="1"> <tr> <td>17</td> <td>■</td> </tr> </table>	17	■
	17	■		

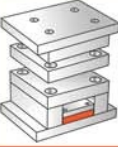
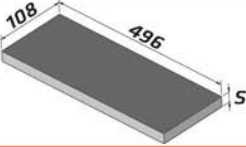
K70 / 196 X 496 / S / ST37 / 7225 / 2312 / 2344				
K70	 	<table border="1"> <tr> <td>22</td> <td>■</td> </tr> </table>	22	■
	22	■		

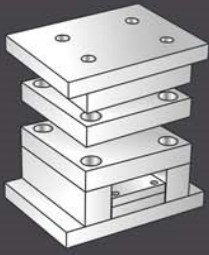

218 X 246

Standards Parts K

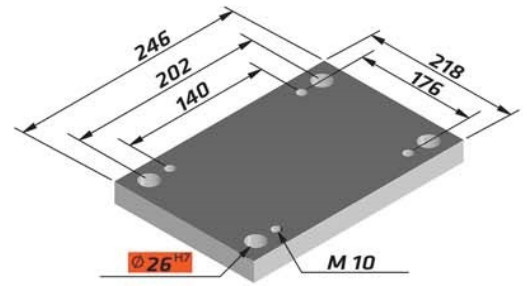

K10 / 218 X 246 / S / ST37 / 7225 / 2312 / 2344

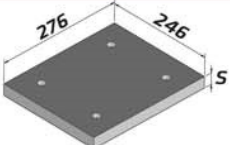
22	■
27	

K11 / 218 X 246 / S / ST37 / 7225 / 2312 / 2344

22	■
27	

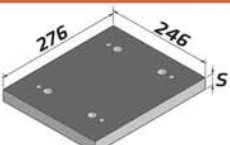
K20 / 218 X 246 / S / ST37 / 7225 / 2312 / 2344

27	■	■
37	■	■
46	■	■
56	■	■
66	■	■
76		
86		

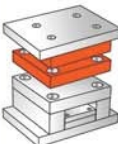
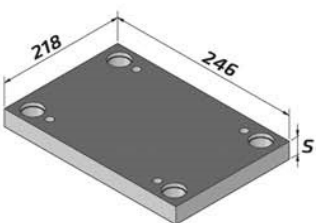
K30 / 218 X 246 / S / ST37 / 7225 / 2312 / 2344

27	■
37	

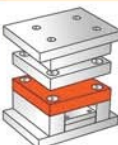
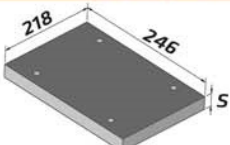
K40 / 218 X 246 / S / ST37 / 7225 / 2312 / 2344

46	■
56	■
76	
96	

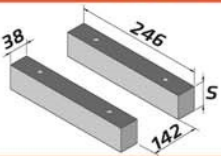
K60 / 218 X 246 / S / ST37 / 7225 / 2312 / 2344



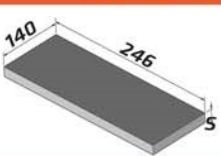

12	■
----	---

K70 / 218 X 246 / S / ST37 / 7225 / 2312 / 2344



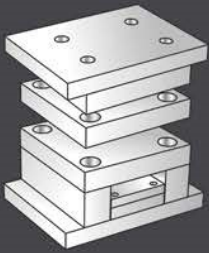

17	■
----	---

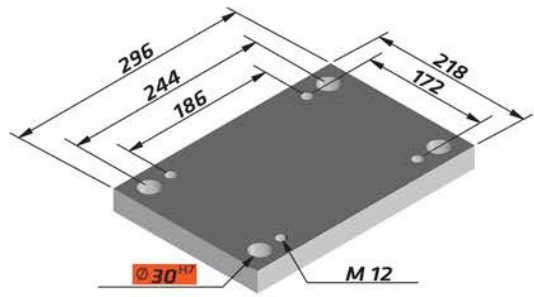

218 X 296

Standards Parts K



	K 10 / 218 X 296 / S / ST37 / 7225 / 2312 / 2344					
K10		27	■			
			37			
K11		27	■			
			37			
K20		27		■	■	
			37	■	■	
			46	■	■	
			56	■	■	
			66	■	■	
			76			
86						
K30		27	■			
			37			
K40		46	■			
			56	■		
			76			
			96			
K60		12	■			
K70		17	■			

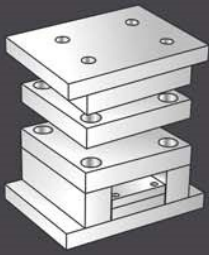

246 X 246

Standards Parts K

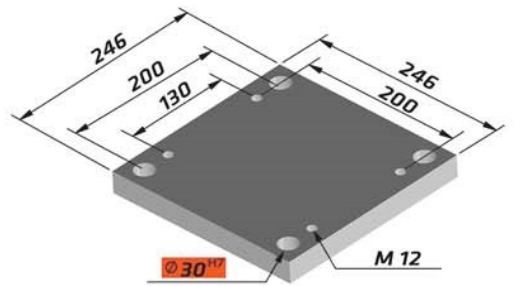

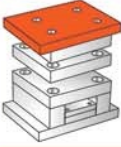
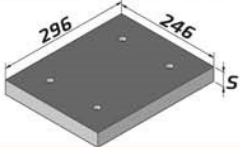
K10			K 10 / 246 X 246 / S / ST37 / 7225 / 2312 / 2344			
			27	■		
37						

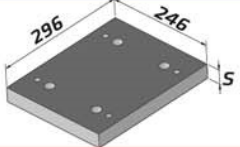
K11			K 11 / 246 X 246 / S / ST37 / 7225 / 2312 / 2344			
			27	■		
37						

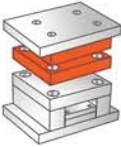
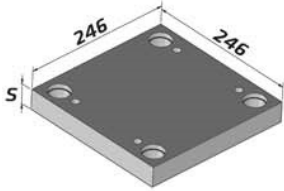
K20			K 20 / 246 X 246 / S / ST37 / 7225 / 2312 / 2344			
			27	■	■	
			37	■	■	
			46	■	■	
			56	■	■	
			66	■	■	
			76			
86						

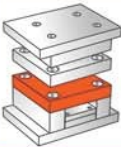
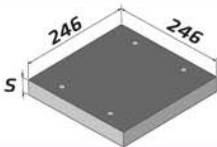
K30			K 30 / 246 X 246 / S / ST37 / 7225 / 2312 / 2344			
			27	■		
37						

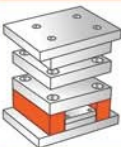
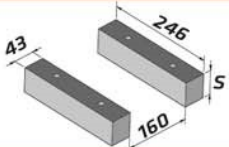
K40			K 40 / 246 X 246 / S / ST37 / 7225 / 2312 / 2344			
			46	■		
			56	■		
			76			
96						

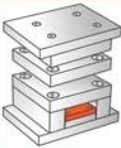
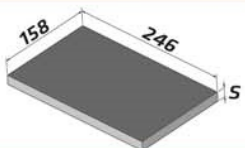
K60			K 60 / 246 X 246 / S / ST37 / 7225 / 2312 / 2344			
			12	■		

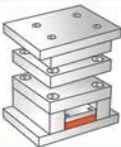
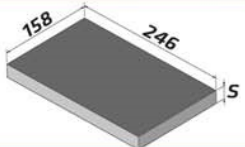
K70			K 70 / 246 X 246 / S / ST37 / 7225 / 2312 / 2344			
			17	■		

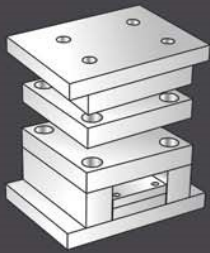

246 X 296

Standards Parts K

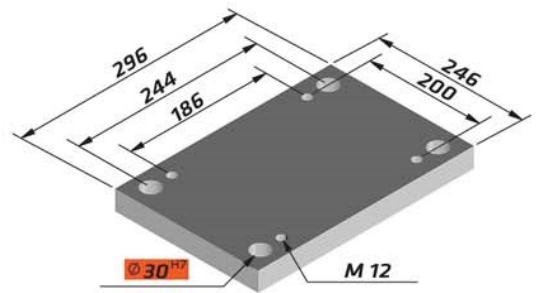

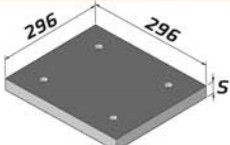
K10			K 10 / 246 X 296 / S / ST37 / 7225 / 2312 / 2344			
			27	■		
37						

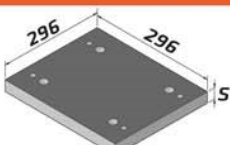
K11			K 11 / 246 X 296 / S / ST37 / 7225 / 2312 / 2344			
			27	■		
37						

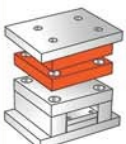
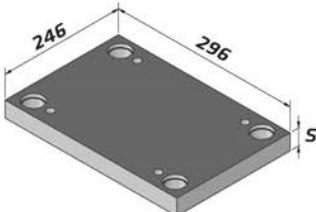
K20			K 20 / 246 X 296 / S / ST37 / 7225 / 2312 / 2344			
			27	■	■	
			37	■	■	
			46	■	■	
			56	■	■	
			66	■	■	
			76			
86						

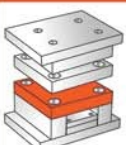
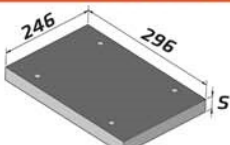
K30			K 30 / 246 X 296 / S / ST37 / 7225 / 2312 / 2344			
			27	■		
37						

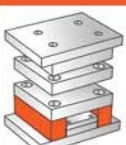
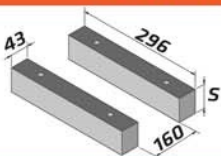
K40			K 40 / 246 X 296 / S / ST37 / 7225 / 2312 / 2344			
			46	■		
			56	■		
			76			
96						

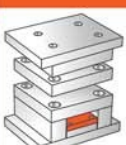
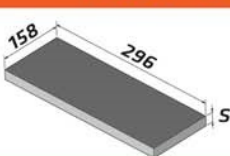
K60			K 60 / 246 X 296 / S / ST37 / 7225 / 2312 / 2344			
			12	■		

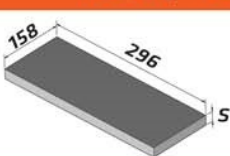
K70			K 70 / 246 X 296 / S / ST37 / 7225 / 2312 / 2344			
			17	■		

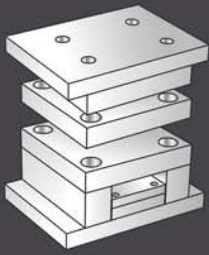

246 X 346

Standards Parts K

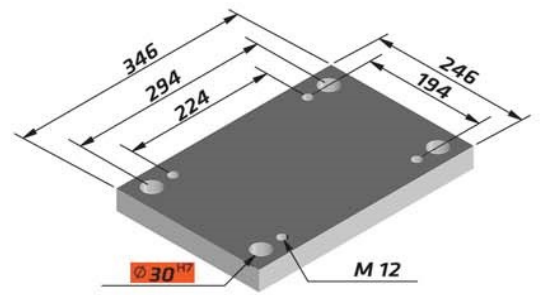

K10 / 246 X 346 / S / ST37 / 7225 / 2312 / 2344

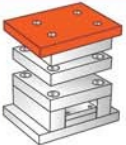
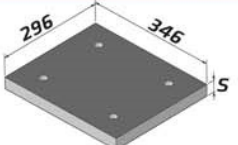
K10			27	■	
			37		

K11 / 246 X 346 / S / ST37 / 7225 / 2312 / 2344

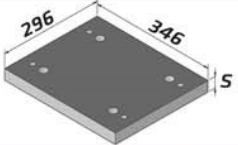
K11			27	■	
			37		

K20 / 246 X 346 / S / ST37 / 7225 / 2312 / 2344

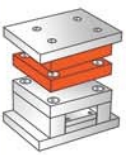
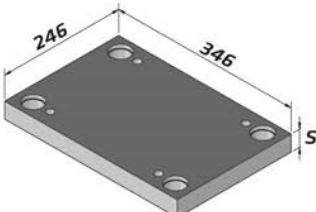
K20			27	■	■
			37	■	■
			46	■	■
			56	■	■
			66	■	■
			76		
86					

K30 / 246 X 346 / S / ST37 / 7225 / 2312 / 2344

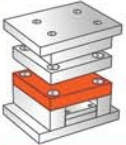
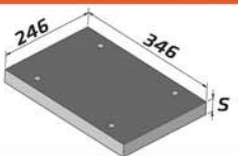
K30			27	■	
			37		

K40 / 246 X 346 / S / ST37 / 7225 / 2312 / 2344

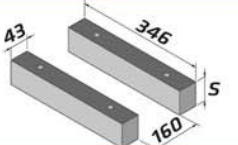
K40			56	■	
			76	■	
			96		

K60 / 246 X 346 / S / ST37 / 7225 / 2312 / 2344

K60			17	■	

K70 / 246 X 346 / S / ST37 / 7225 / 2312 / 2344

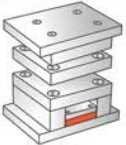
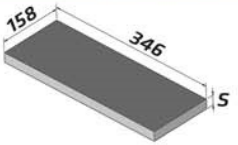

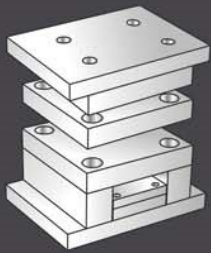

K70			22	■	

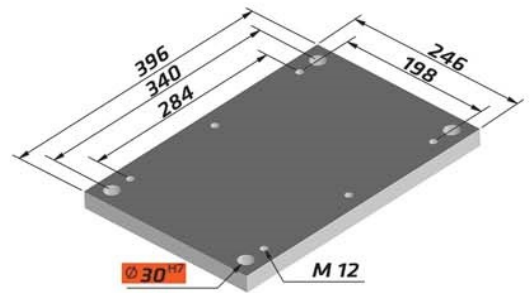

246 X 396

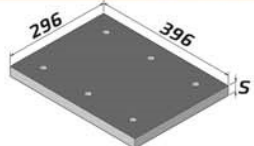
Standards Parts K

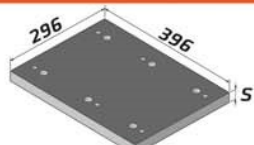
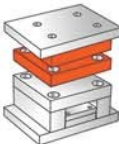
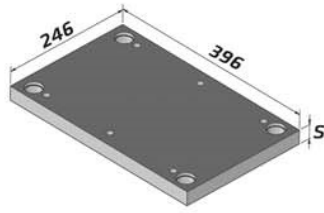
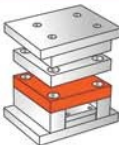
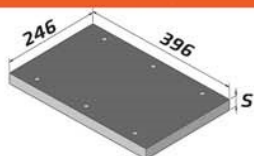

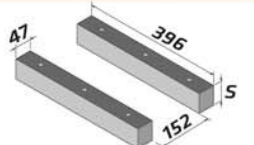
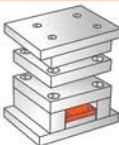
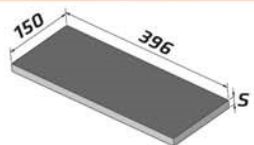
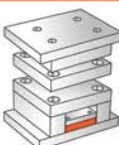
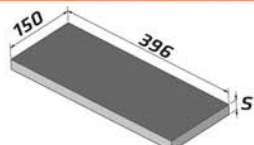

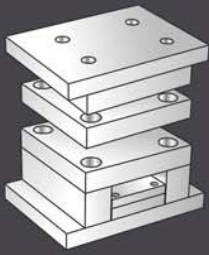
		K 10 / 246 X 396 / S / ST37 / 7225 / 2312 / 2344			
K10			27	■	
			37		
K11			27	■	
			37		
K20			27	■	■
			37	■	■
			46	■	■
			56	■	■
			66	■	■
			76		
			86		
K30			27	■	
			37		
K40			56	■	
			76	■	
			96		
K60			17	■	
K70			22	■	

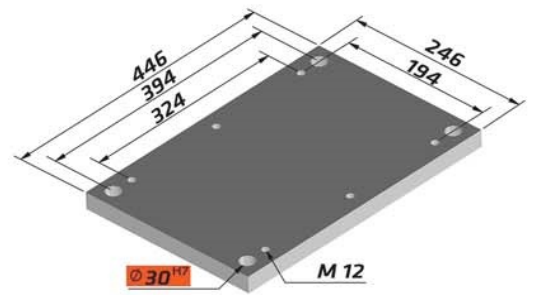

246 X 446

Standards Parts K

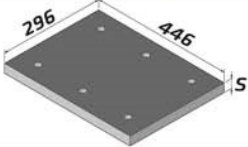

K10			K 10 / 246 X 446 / S / ST37 / 7225 / 2312 / 2344			
			27	■		
37						

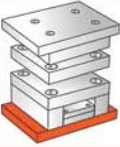
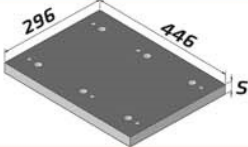

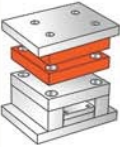
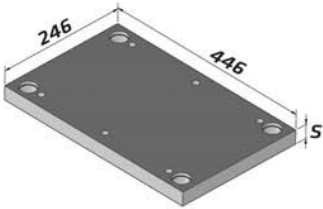
K11			K 11 / 246 X 446 / S / ST37 / 7225 / 2312 / 2344			
			27	■		
37						

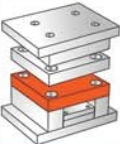
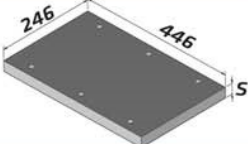
K20			K 20 / 246 X 446 / S / ST37 / 7225 / 2312 / 2344			
			27		■	■
			37		■	■
			46		■	■
			56		■	■
			66		■	■
			76			
86						

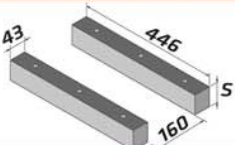
K30			K 30 / 246 X 446 / S / ST37 / 7225 / 2312 / 2344			
			27	■		
37						

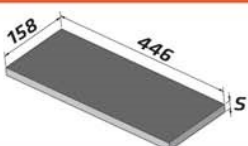
K40			K 40 / 246 X 446 / S / ST37 / 7225 / 2312 / 2344			
			56	■		
			76	■		
96						

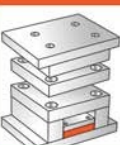
K60			K 60 / 246 X 446 / S / ST37 / 7225 / 2312 / 2344			
			17	■		

K70			K 70 / 246 X 446 / S / ST37 / 7225 / 2312 / 2344			
			22	■		

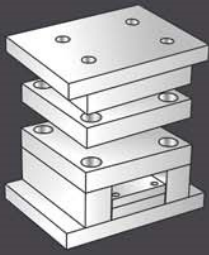

246 X 496

Standards Parts K

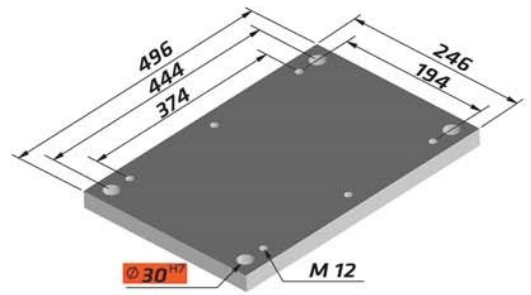

K10 / 246 X 496 / S / ST37 / 7225 / 2312 / 2344		
K10	27	■
	37	

K11 / 246 X 496 / S / ST37 / 7225 / 2312 / 2344		
K11	27	■
	37	

K20 / 246 X 496 / S / ST37 / 7225 / 2312 / 2344			
K20	27	■	■
	37	■	■
	46	■	■
	56	■	■
	66	■	■
	76		
86			

K30 / 246 X 496 / S / ST37 / 7225 / 2312 / 2344		
K30	27	■
	37	

K40 / 246 X 496 / S / ST37 / 7225 / 2312 / 2344		
K40	56	■
	76	■
	96	

K60 / 246 X 496 / S / ST37 / 7225 / 2312 / 2344		
K60	17	■

K70 / 246 X 496 / S / ST37 / 7225 / 2312 / 2344		
K70	22	■

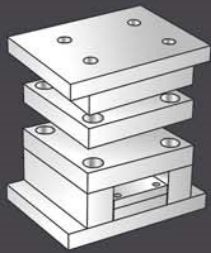

296 X 296

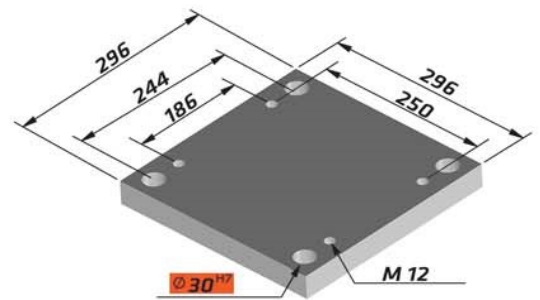

Standards Parts K

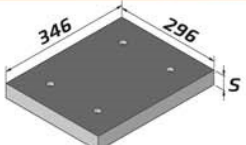

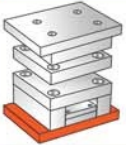
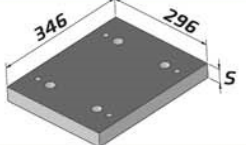
K10	K 10 / 296 X 296 / S / ST37 / 7225 / 2312 / 2344						
			27	■			
		37					

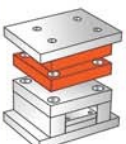
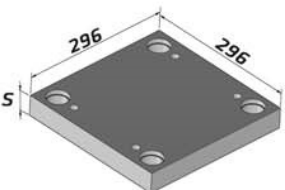
K11	K 11 / 296 X 296 / S / ST37 / 7225 / 2312 / 2344						
			27	■			
		37					

K20	K 20 / 296 X 296 / S / ST37 / 7225 / 2312 / 2344							
			27	■	■			
			37	■	■			
			46	■	■			
			56	■	■			
			66	■	■			
			76					
86								

K30	K 30 / 296 X 296 / S / ST37 / 7225 / 2312 / 2344						
			27	■			
		37					

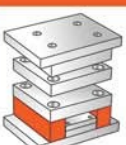
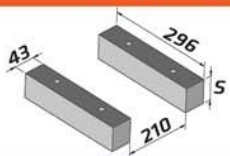
K40	K 40 / 296 X 296 / S / ST37 / 7225 / 2312 / 2344							
			56	■				
			76	■				
96								

K60	K 60 / 296 X 296 / S / ST37 / 7225 / 2312 / 2344						
			17	■			

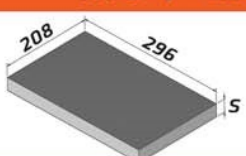
K70	K 70 / 296 X 296 / S / ST37 / 7225 / 2312 / 2344						
			22	■			

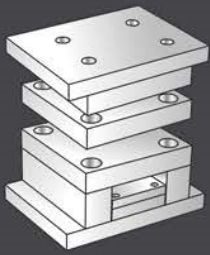

296 X 346

Standards Parts K

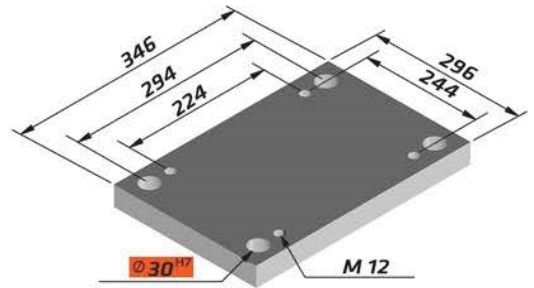

K10 / 296 X 346 / S / ST37 / 7225 / 2312 / 2344	
K10	27 <input type="checkbox"/>
	37 <input type="checkbox"/>

K11 / 296 X 346 / S / ST37 / 7225 / 2312 / 2344	
K11	27 <input type="checkbox"/>
	37 <input type="checkbox"/>

K20 / 296 X 346 / S / ST37 / 7225 / 2312 / 2344	
K20	27 <input type="checkbox"/> <input type="checkbox"/>
	37 <input type="checkbox"/> <input type="checkbox"/>
	46 <input type="checkbox"/> <input type="checkbox"/>
	56 <input type="checkbox"/> <input type="checkbox"/>
	66 <input type="checkbox"/> <input type="checkbox"/>
	76 <input type="checkbox"/>
	86 <input type="checkbox"/>

K30 / 296 X 346 / S / ST37 / 7225 / 2312 / 2344	
K30	27 <input type="checkbox"/>
	37 <input type="checkbox"/>

K40 / 296 X 346 / S / ST37 / 7225 / 2312 / 2344	
K40	56 <input type="checkbox"/>
	76 <input type="checkbox"/>
	96 <input type="checkbox"/>

K60 / 296 X 346 / S / ST37 / 7225 / 2312 / 2344	
K60	17 <input type="checkbox"/>

K70 / 296 X 346 / S / ST37 / 7225 / 2312 / 2344	
K70	22 <input type="checkbox"/>

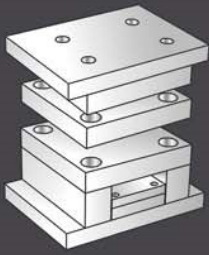

296 X 396

Standards Parts K

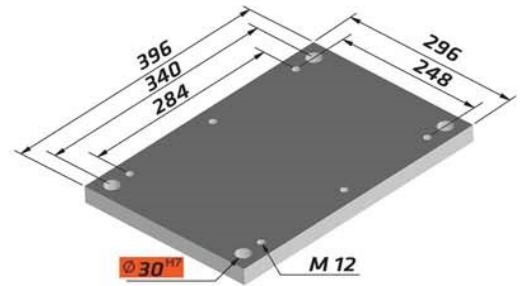

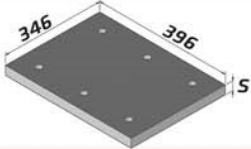
K 10 / 296 X 396 / S / ST37 / 7225 / 2312 / 2344			
K10	 	27	<input type="checkbox"/>
		37	

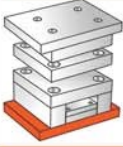
K 11 / 296 X 396 / S / ST37 / 7225 / 2312 / 2344			
K11	 	27	<input type="checkbox"/>
		37	

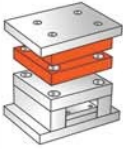
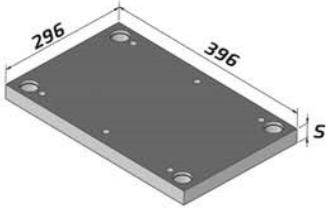
K 20 / 296 X 396 / S / ST37 / 7225 / 2312 / 2344				
K20	 	27	<input type="checkbox"/>	<input type="checkbox"/>
		37	<input type="checkbox"/>	<input type="checkbox"/>
		46	<input type="checkbox"/>	<input type="checkbox"/>
		56	<input type="checkbox"/>	<input type="checkbox"/>
		66	<input type="checkbox"/>	<input type="checkbox"/>
		76		
		86		

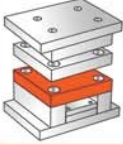
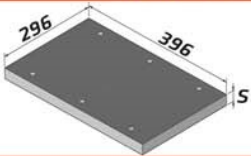
K 30 / 296 X 396 / S / ST37 / 7225 / 2312 / 2344			
K30	 	27	<input type="checkbox"/>
		37	

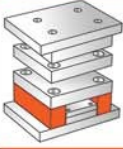
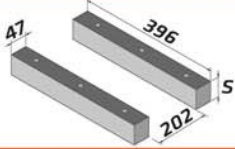
K 40 / 296 X 396 / S / ST37 / 7225 / 2312 / 2344			
K40	 	56	<input type="checkbox"/>
		76	<input type="checkbox"/>
		96	

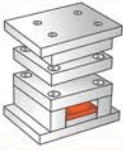
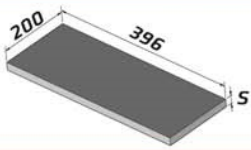
K 60 / 296 X 396 / S / ST37 / 7225 / 2312 / 2344			
K60	 	17	<input type="checkbox"/>

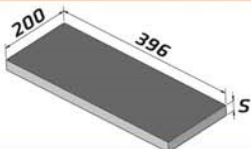
K 70 / 296 X 396 / S / ST37 / 7225 / 2312 / 2344			
K70	 	22	<input type="checkbox"/>

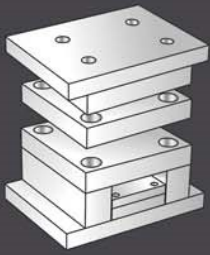

296 X 446

Standards Parts K

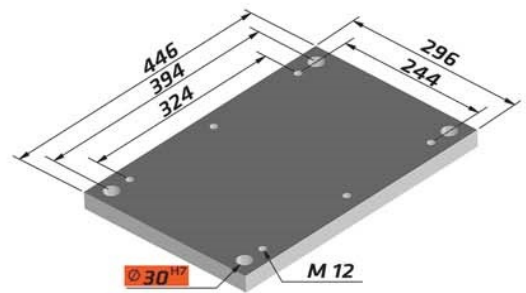

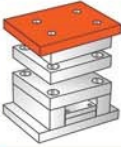
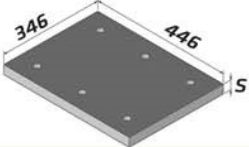
K10			K 10 / 296 X 446 / S / ST37 / 7225 / 2312 / 2344			
			27	■		
			37			

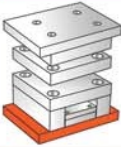
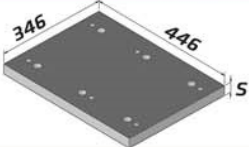
K11			K 11 / 296 X 446 / S / ST37 / 7225 / 2312 / 2344			
			27	■		
			37			

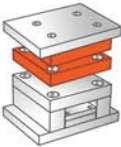
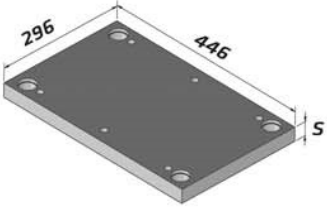
K20			K 20 / 296 X 446 / S / ST37 / 7225 / 2312 / 2344			
			27		■	■
			37		■	■
			46		■	■
			56		■	■
			66		■	■
			76			
86						

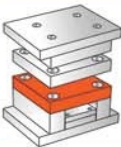
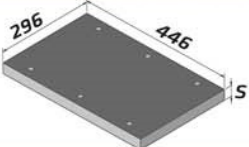
K30			K 30 / 296 X 446 / S / ST37 / 7225 / 2312 / 2344			
			27	■		
			37			

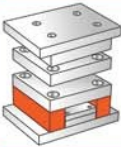
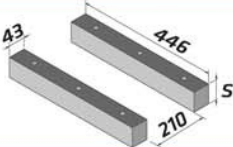
K40			K 40 / 296 X 446 / S / ST37 / 7225 / 2312 / 2344			
			56	■		
			76	■		
			96			

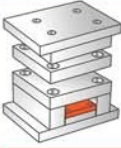
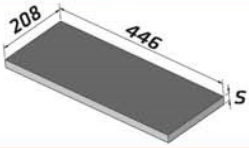
K60			K 60 / 296 X 446 / S / ST37 / 7225 / 2312 / 2344			
			17	■		

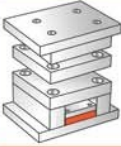
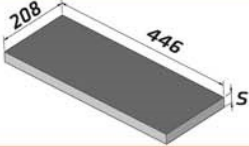
K70			K 70 / 296 X 446 / S / ST37 / 7225 / 2312 / 2344			
			22	■		

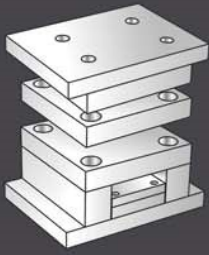

296 X 496

Standards Parts K

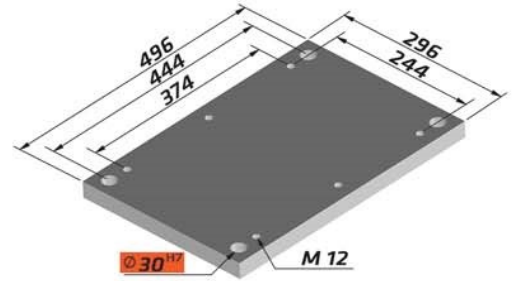

K10 / 296 X 496 / S / ST37 / 7225 / 2312 / 2344

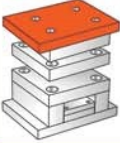
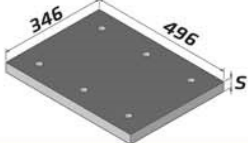
27	■
37	

K11 / 296 X 496 / S / ST37 / 7225 / 2312 / 2344

27	■
37	

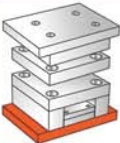
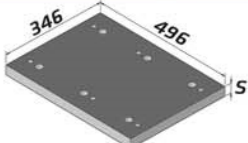
K20 / 296 X 496 / S / ST37 / 7225 / 2312 / 2344

27	■	■
37	■	■
46	■	■
56	■	■
66	■	■
76		
86		

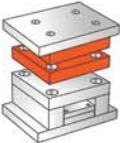
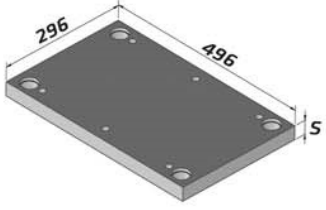
K30 / 296 X 496 / S / ST37 / 7225 / 2312 / 2344

27	■
37	

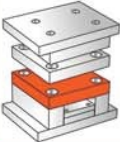
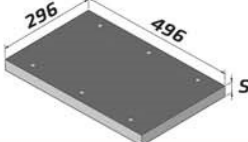
K40 / 296 X 496 / S / ST37 / 7225 / 2312 / 2344

56	■
76	■
96	

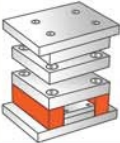
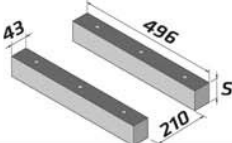
K60 / 296 X 496 / S / ST37 / 7225 / 2312 / 2344



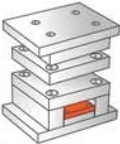

17	■
----	---

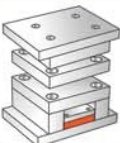
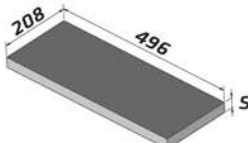
K70 / 296 X 496 / S / ST37 / 7225 / 2312 / 2344



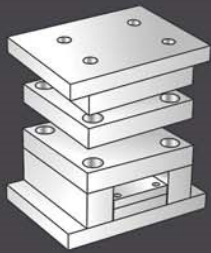

22	■
----	---

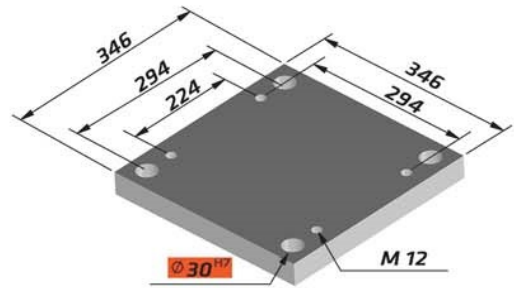

346 X 346

Standards Parts K

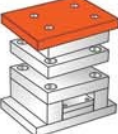
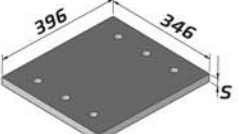

K10 / 346 X 346 / S / ST37 / 7225 / 2312 / 2344

27	■
37	

K11 / 346 X 346 / S / ST37 / 7225 / 2312 / 2344

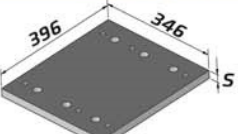

27	■
37	

K20 / 346 X 346 / S / ST37 / 7225 / 2312 / 2344

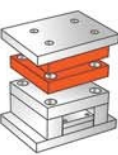
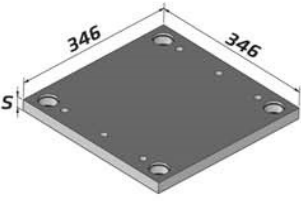
27	■	■
37	■	■
46	■	■
56	■	■
66	■	■
76		
86		

K30 / 346 X 346 / S / ST37 / 7225 / 2312 / 2344

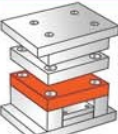
27	■
37	

K40 / 346 X 346 / S / ST37 / 7225 / 2312 / 2344

56	■
76	■
96	

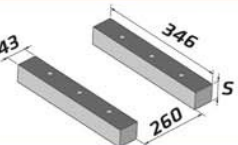
K60 / 346 X 346 / S / ST37 / 7225 / 2312 / 2344





17	■
----	---

K70 / 346 X 346 / S / ST37 / 7225 / 2312 / 2344



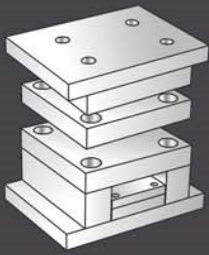

22	■
----	---

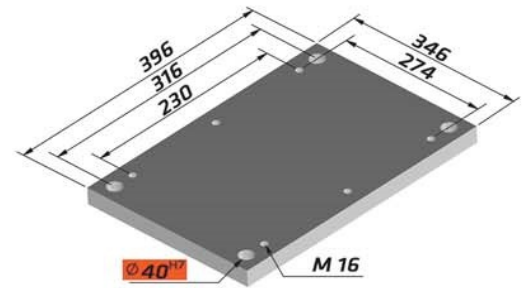

346 X 396

Standards Parts K

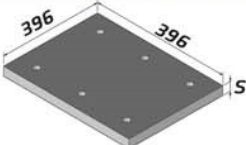

K10 / 346 X 396 / S / ST37 / 7225 / 2312 / 2344

27	■
37	

K11 / 346 X 396 / S / ST37 / 7225 / 2312 / 2344

27	■
37	

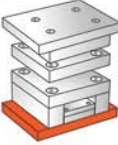
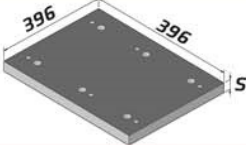
K20 / 346 X 396 / S / ST37 / 7225 / 2312 / 2344

27	■	■
37	■	■
46	■	■
56	■	■
66	■	■
76		
86		

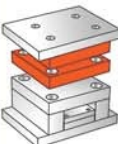
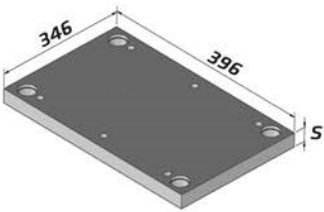
K30 / 346 X 396 / S / ST37 / 7225 / 2312 / 2344

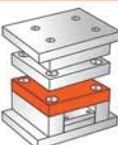
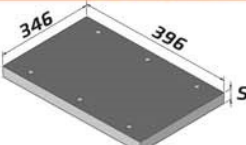

27	■
37	

K40 / 346 X 396 / S / ST37 / 7225 / 2312 / 2344

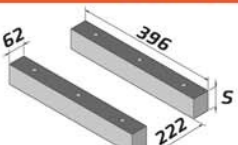

56	■
76	■
96	

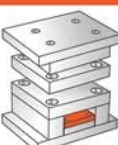
K60 / 346 X 396 / S / ST37 / 7225 / 2312 / 2344





17	■
----	---

K70 / 346 X 396 / S / ST37 / 7225 / 2312 / 2344



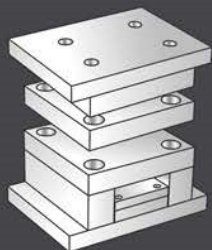

22	■
----	---

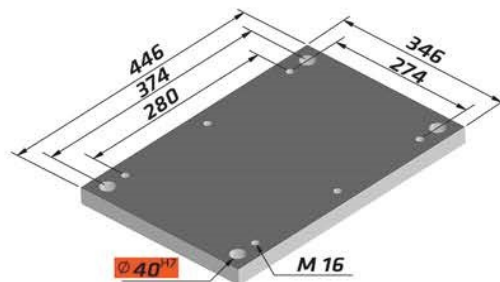

346 X 446

Standards Parts K



K10 / 346 X 446 / S / ST37 / 7225 / 2312 / 2344			
K10		27	■
		37	

K11 / 346 X 446 / S / ST37 / 7225 / 2312 / 2344			
K11		27	■
		37	

K20 / 346 X 446 / S / ST37 / 7225 / 2312 / 2344				
K20		27	■	■
		37	■	■
		46	■	■
		56	■	■
		66	■	■
		76		
	86			

K30 / 346 X 446 / S / ST37 / 7225 / 2312 / 2344			
K30		27	■
		37	

K40 / 346 X 446 / S / ST37 / 7225 / 2312 / 2344			
K40		56	■
		76	■
		96	

K60 / 346 X 446 / S / ST37 / 7225 / 2312 / 2344			
K60		17	■

K70 / 346 X 446 / S / ST37 / 7225 / 2312 / 2344			
K70		22	■

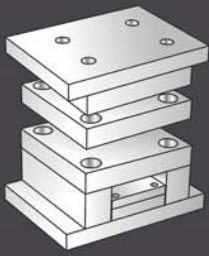

346 X 496

Standards Parts K

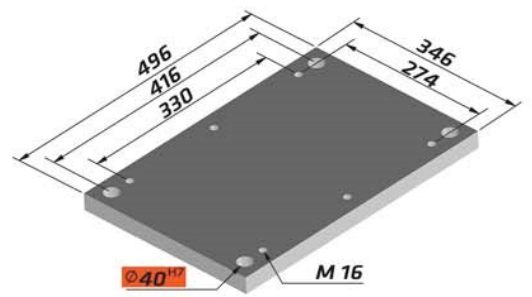

K10 / 346 X 496 / S / ST37 / 7225 / 2312 / 2344

K10

27	■
37	

K11 / 346 X 496 / S / ST37 / 7225 / 2312 / 2344

K11

27	■
37	

K20 / 346 X 496 / S / ST37 / 7225 / 2312 / 2344

K20

27	■	■
37	■	■
46	■	■
56	■	■
66	■	■
76		
86		

K30 / 346 X 496 / S / ST37 / 7225 / 2312 / 2344

K30

27	■
37	

K40 / 346 X 496 / S / ST37 / 7225 / 2312 / 2344

K40

56	■
76	■
96	

K60 / 346 X 496 / S / ST37 / 7225 / 2312 / 2344

K60

17	■
----	---

K70 / 346 X 496 / S / ST37 / 7225 / 2312 / 2344

K70

22	■
----	---

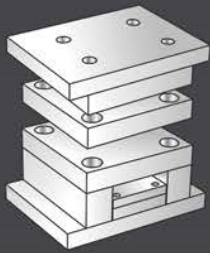

396 X 396

Standards Parts K

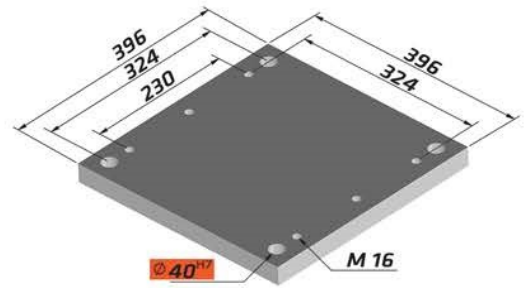

K10 / 396 X 396 / S / ST37 / 7225 / 2312 / 2344		
K10	27	<input type="checkbox"/>
	37	<input type="checkbox"/>

K11 / 396 X 396 / S / ST37 / 7225 / 2312 / 2344		
K11	27	<input type="checkbox"/>
	37	<input type="checkbox"/>

K20 / 396 X 396 / S / ST37 / 7225 / 2312 / 2344			
K20	27	<input type="checkbox"/>	<input type="checkbox"/>
	37	<input type="checkbox"/>	<input type="checkbox"/>
	46	<input type="checkbox"/>	<input type="checkbox"/>
	56	<input type="checkbox"/>	<input type="checkbox"/>
	66	<input type="checkbox"/>	<input type="checkbox"/>
	76	<input type="checkbox"/>	<input type="checkbox"/>
	86	<input type="checkbox"/>	<input type="checkbox"/>

K30 / 396 X 396 / S / ST37 / 7225 / 2312 / 2344		
K30	27	<input type="checkbox"/>
	37	<input type="checkbox"/>

K40 / 396 X 396 / S / ST37 / 7225 / 2312 / 2344		
K40	56	<input type="checkbox"/>
	76	<input type="checkbox"/>
	96	<input type="checkbox"/>

K60 / 396 X 396 / S / ST37 / 7225 / 2312 / 2344		
K60	17	<input type="checkbox"/>
		<input type="checkbox"/>

K70 / 396 X 396 / S / ST37 / 7225 / 2312 / 2344		
K70	22	<input type="checkbox"/>
		<input type="checkbox"/>

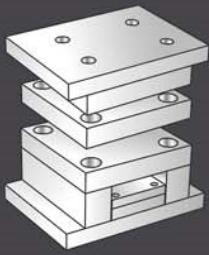

396 X 446

Standards Parts K

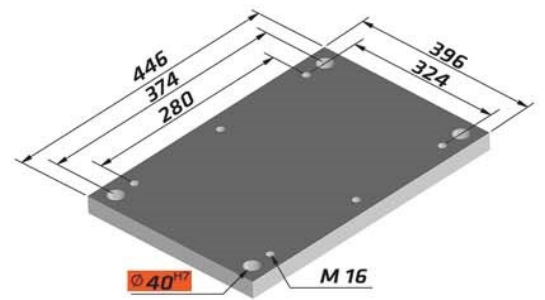

K10 / 396 X 446 / S / ST37 / 7225 / 2312 / 2344	
K10	27 <input type="checkbox"/>
	37 <input type="checkbox"/>

K11 / 396 X 446 / S / ST37 / 7225 / 2312 / 2344	
K11	27 <input type="checkbox"/>
	37 <input type="checkbox"/>

K20 / 396 X 446 / S / ST37 / 7225 / 2312 / 2344	
K20	27 <input type="checkbox"/> <input type="checkbox"/>
	37 <input type="checkbox"/> <input type="checkbox"/>
	46 <input type="checkbox"/> <input type="checkbox"/>
	56 <input type="checkbox"/> <input type="checkbox"/>
	66 <input type="checkbox"/> <input type="checkbox"/>
	76 <input type="checkbox"/>
	86 <input type="checkbox"/>

K30 / 396 X 446 / S / ST37 / 7225 / 2312 / 2344	
K30	27 <input type="checkbox"/>
	37 <input type="checkbox"/>

K40 / 396 X 446 / S / ST37 / 7225 / 2312 / 2344	
K40	56 <input type="checkbox"/>
	76 <input type="checkbox"/>
	96 <input type="checkbox"/>

K60 / 396 X 446 / S / ST37 / 7225 / 2312 / 2344	
K60	17 <input type="checkbox"/>

K70 / 396 X 446 / S / ST37 / 7225 / 2312 / 2344	
K70	22 <input type="checkbox"/>

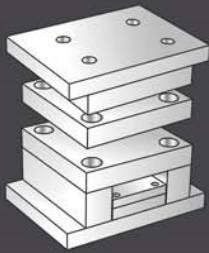

396 X 496

Standards Parts K

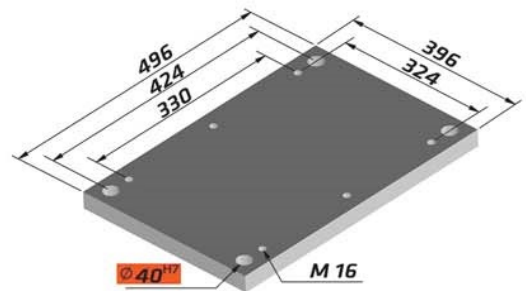

K 10 / 396 X 496 / S / ST37 / 7225 / 2312 / 2344

K10

27	■
37	

K 11 / 396 X 496 / S / ST37 / 7225 / 2312 / 2344

K11

27	■
37	

K 20 / 396 X 496 / S / ST37 / 7225 / 2312 / 2344

K20

27	■	■
37	■	■
46	■	■
56	■	■
66	■	■
76		
86		

K 30 / 396 X 496 / S / ST37 / 7225 / 2312 / 2344

K30

27	■
37	

K 40 / 396 X 496 / S / ST37 / 7225 / 2312 / 2344

K40

66	■
76	■
96	

K 60 / 396 X 496 / S / ST37 / 7225 / 2312 / 2344

K60

22	■
----	---

K 70 / 396 X 496 / S / ST37 / 7225 / 2312 / 2344

K70

27	■
----	---

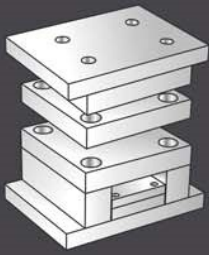

446 X 446

Standards Parts K

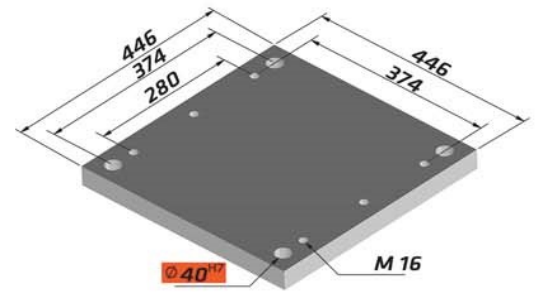

K10 / 446 X 446 / S / ST37 / 7225 / 2312 / 2344

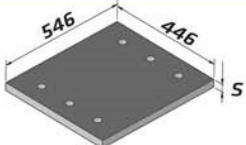
27	■
37	

K11 / 446 X 446 / S / ST37 / 7225 / 2312 / 2344

27	■
37	

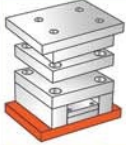
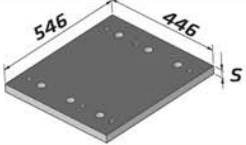
K20 / 446 X 446 / S / ST37 / 7225 / 2312 / 2344

27	■	■
37	■	■
46	■	■
56	■	■
66	■	■
76		
86		

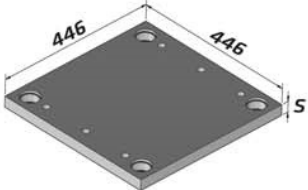
K30 / 446 X 446 / S / ST37 / 7225 / 2312 / 2344

27	■
37	

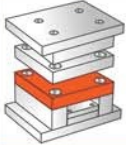
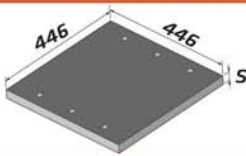
K40 / 446 X 446 / S / ST37 / 7225 / 2312 / 2344

66	■
76	■
96	

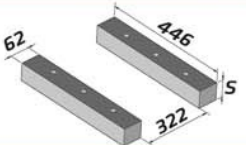
K60 / 446 X 446 / S / ST37 / 7225 / 2312 / 2344



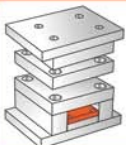
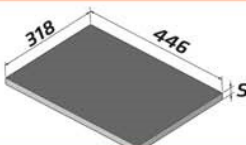

22	■
----	---

K70 / 446 X 446 / S / ST37 / 7225 / 2312 / 2344



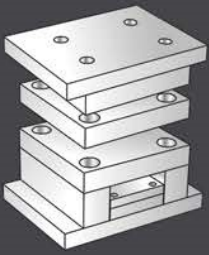



27	■
----	---

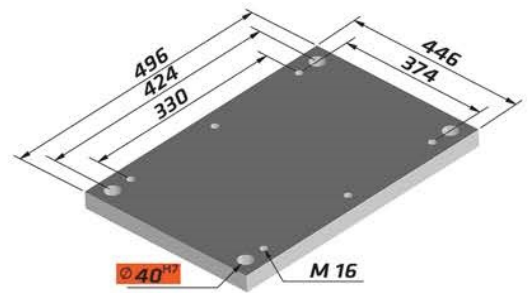

446 X 496

Standards Parts K

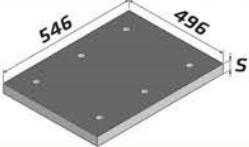

K10			K 10 / 446 X 496 / S / ST37 / 7225 / 2312 / 2344			
			27	■		
37						

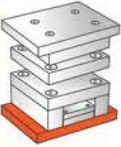
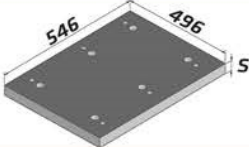
K11			K 11 / 446 X 496 / S / ST37 / 7225 / 2312 / 2344			
			27	■		
37						

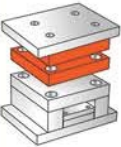
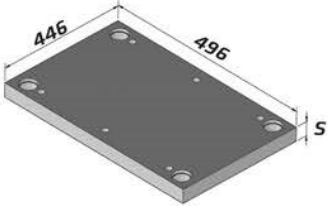
K20			K 20 / 446 X 496 / S / ST37 / 7225 / 2312 / 2344			
			27	■	■	
			37	■	■	
			46	■	■	
			56	■	■	
			66	■	■	
			76			
86						

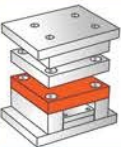
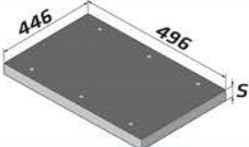
K30			K 30 / 446 X 496 / S / ST37 / 7225 / 2312 / 2344			
			27	■		
37						

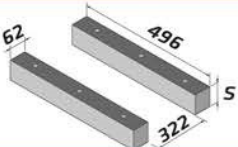
K40			K 40 / 446 X 496 / S / ST37 / 7225 / 2312 / 2344			
			66	■		
			76	■		
96						

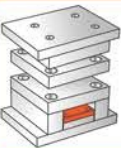
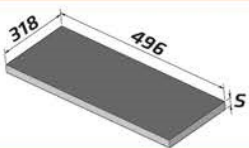
K60			K 60 / 446 X 496 / S / ST37 / 7225 / 2312 / 2344			
			22	■		

K70			K 70 / 446 X 496 / S / ST37 / 7225 / 2312 / 2344			
			27	■		

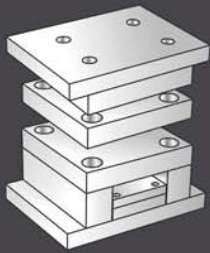

496 X 496

Standards Parts K

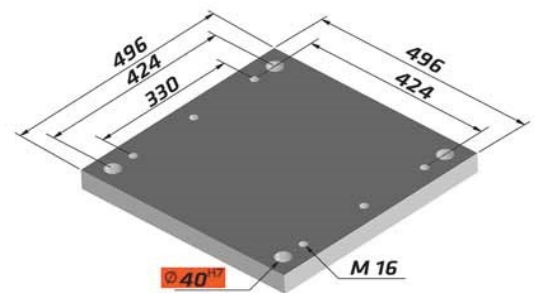

K10

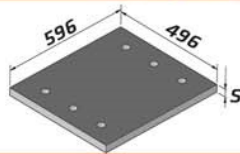
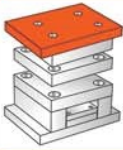

K 10 / 496 X 496 / S / ST37 / 7225 / 2312 / 2344

27	■
37	

K11

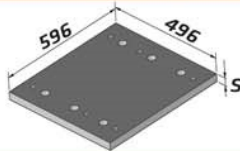
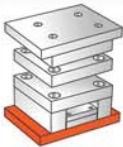

K 11 / 496 X 496 / S / ST37 / 7225 / 2312 / 2344

27	■
37	

K20

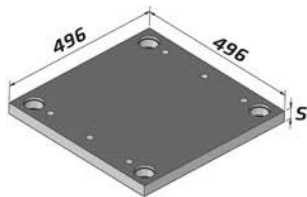
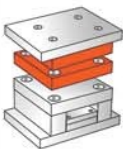

K 20 / 496 X 496 / S / ST37 / 7225 / 2312 / 2344

27	■	■
37	■	■
46	■	■
56	■	■
66	■	■
76		
86		

K30

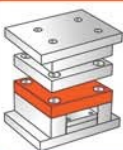

K 30 / 496 X 496 / S / ST37 / 7225 / 2312 / 2344

27	■
37	

K40

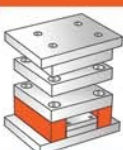

K 40 / 496 X 496 / S / ST37 / 7225 / 2312 / 2344

66	■
76	■
96	

K60

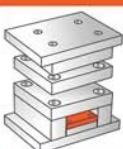

K 60 / 496 X 496 / S / ST37 / 7225 / 2312 / 2344

22	■
----	---

K70

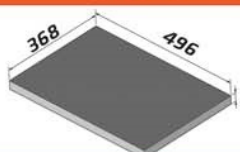
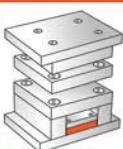

K 70 / 496 X 496 / S / ST37 / 7225 / 2312 / 2344

27	■
----	---

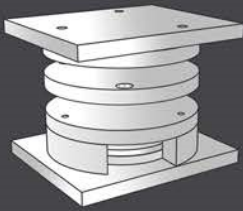

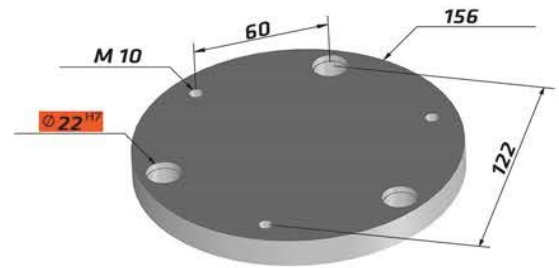

156 - 3

Standards Parts K

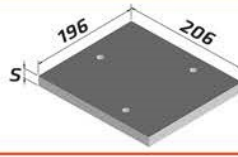

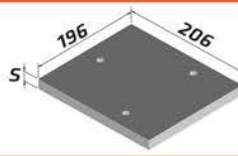

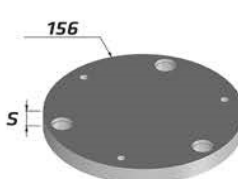

K10			K 10 / 156 - 3 / S / ST37 / 7225 / 2312 / 2344			
			22	■		
			27			



K11			K 11 / 156 - 3 / S / ST37 / 7225 / 2312 / 2344			
			22	■		
			27			

K20			K 20 / 156 - 3 / S / ST37 / 7225 / 2312 / 2344			
			27	■	■	
			37	■	■	
			46	■	■	
			56	■	■	
			66	■	■	
			76			

K30			K 30 / 156 - 3 / S / ST37 / 7225 / 2312 / 2344			
			27	■		

K40			K 40 / 156 - 3 / S / ST37 / 7225 / 2312 / 2344			
			46	■		
			56	■		

K60			K 60 / 156 - 3 / S / ST37 / 7225 / 2312 / 2344			
			12	■		

K70			K 70 / 156 - 3 / S / ST37 / 7225 / 2312 / 2344			
			17	■		

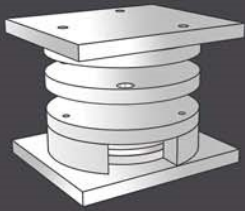

196 - 3

Standards Parts

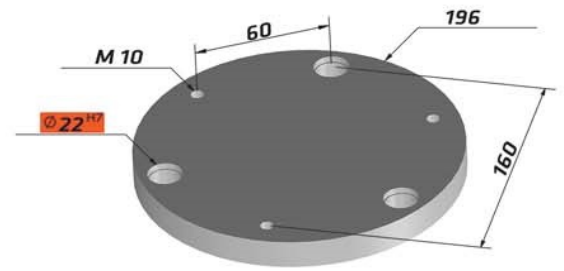

K10			K 10 / 196 - 3 / S / ST37 / 7225 / 2312 / 2344			
			27	■		

K11			K 11 / 196 - 3 / S / ST37 / 7225 / 2312 / 2344			
			27	■		

K20			K 20 / 196 - 3 / S / ST37 / 7225 / 2312 / 2344			
			27	■	■	
			37	■	■	
			46	■	■	
			56	■	■	
			66	■	■	

K30			K 30 / 196 - 3 / S / ST37 / 7225 / 2312 / 2344			
			27	■		

K40			K 40 / 196 - 3 / S / ST37 / 7225 / 2312 / 2344			
			46	■		
			56	■		

K60			K 60 / 196 - 3 / S / ST37 / 7225 / 2312 / 2344			
			12	■		

K70			K 70 / 196 - 3 / S / ST37 / 7225 / 2312 / 2344			
			17	■		

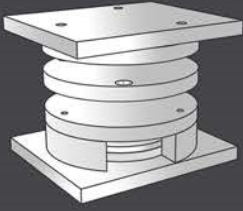

246 - 3

Standards Parts K

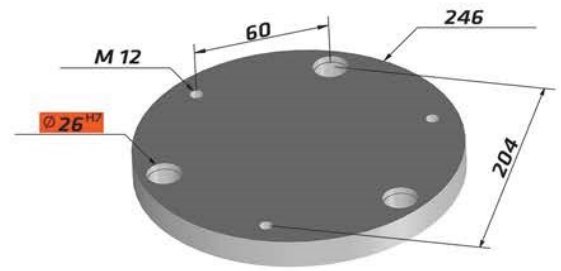

K10			K 10 / 246 - 3 / S / ST37 / 7225 / 2312 / 2344			
			27	<input checked="" type="checkbox"/>		

K11			K 11 / 246 - 3 / S / ST37 / 7225 / 2312 / 2344			
			27	<input checked="" type="checkbox"/>		

K20			K 20 / 246 - 3 / S / ST37 / 7225 / 2312 / 2344			
			27	<input checked="" type="checkbox"/>	<input checked="" type="checkbox"/>	
			37	<input checked="" type="checkbox"/>	<input checked="" type="checkbox"/>	
			46	<input checked="" type="checkbox"/>	<input checked="" type="checkbox"/>	
			56	<input checked="" type="checkbox"/>	<input checked="" type="checkbox"/>	
			66	<input checked="" type="checkbox"/>	<input checked="" type="checkbox"/>	

K30			K 30 / 246 - 3 / S / ST37 / 7225 / 2312 / 2344			
			27	<input checked="" type="checkbox"/>		

K40			K 40 / 246 - 3 / S / ST37 / 7225 / 2312 / 2344			
			46	<input checked="" type="checkbox"/>		
			56	<input checked="" type="checkbox"/>		

K60			K 60 / 246 - 3 / S / ST37 / 7225 / 2312 / 2344			
			12	<input checked="" type="checkbox"/>		

K70			K 70 / 246 - 3 / S / ST37 / 7225 / 2312 / 2344			
			17	<input checked="" type="checkbox"/>		

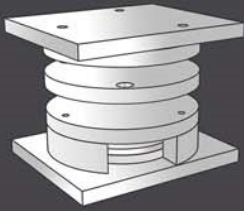

296 - 3

Standards Parts K

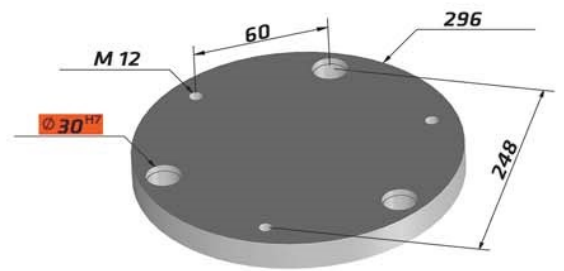

K10			K 10 / 296 - 3 / S / ST37 / 7225 / 2312 / 2344			
			27	■		

K11			K 11 / 296 - 3 / S / ST37 / 7225 / 2312 / 2344			
			27	■		

K20			K 20 / 296 - 3 / S / ST37 / 7225 / 2312 / 2344			
			27	■	■	
			37	■	■	
			46	■	■	
			56	■	■	
			66	■	■	

K30			K 30 / 296 - 3 / S / ST37 / 7225 / 2312 / 2344			
			27	■		

K40			K 40 / 296 - 3 / S / ST37 / 7225 / 2312 / 2344			
			56	■		
			66	■		

K60			K 60 / 296 - 3 / S / ST37 / 7225 / 2312 / 2344			
			12	■		

K70			K 70 / 296 - 3 / S / ST37 / 7225 / 2312 / 2344			
			17	■		