

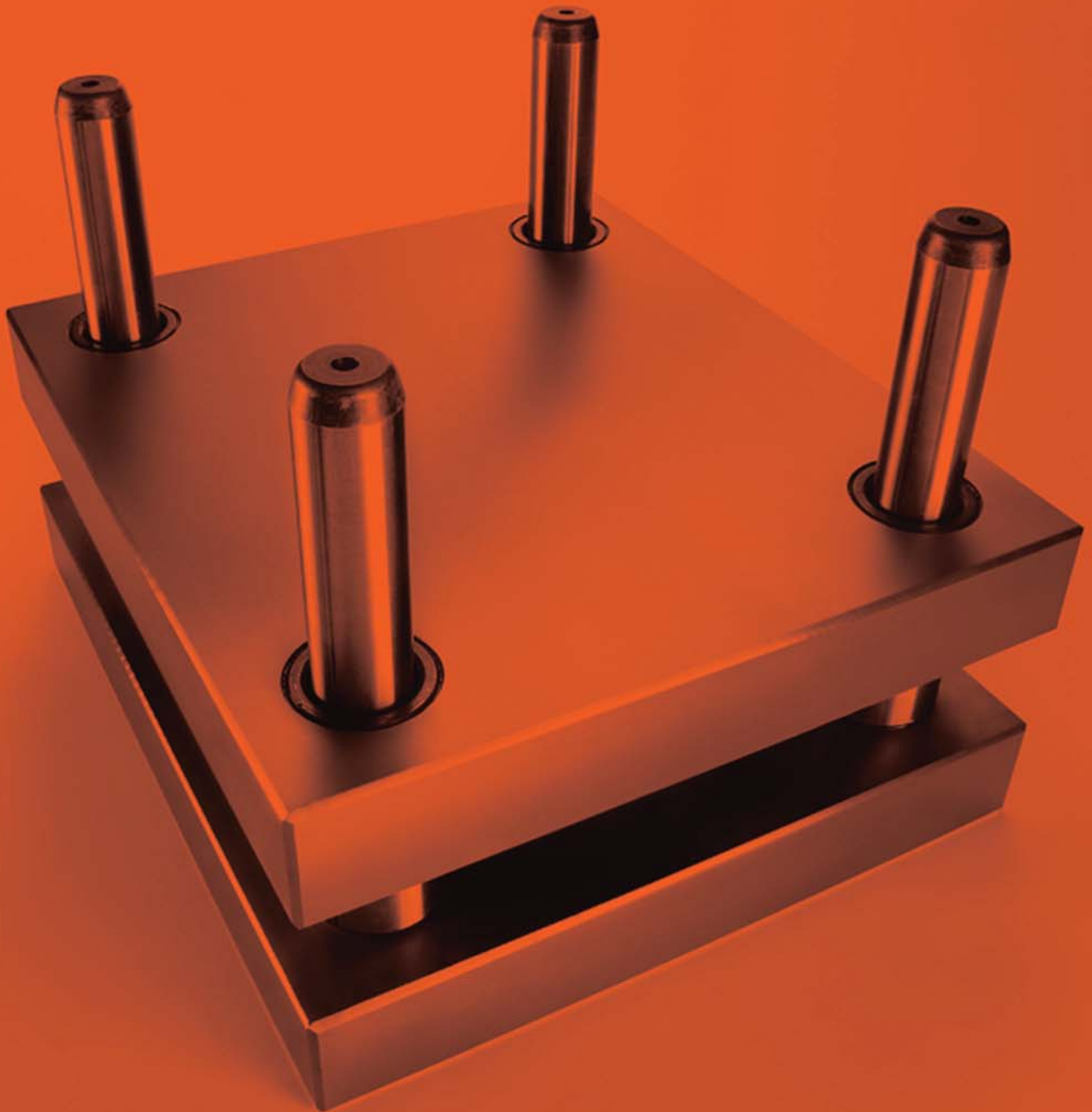

Standards Parts





HL

Die Sets Without stripper

ALL-STEEL DIE SET

Without Stripper

Plates Material : St37 , 1.1730 , 1.7225

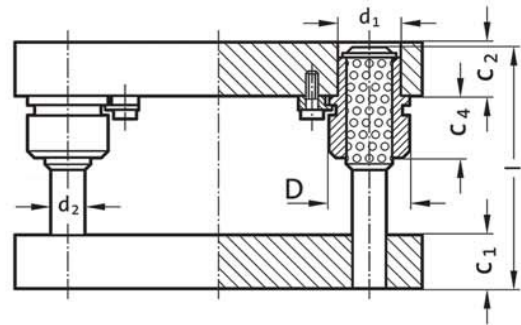

HL/1

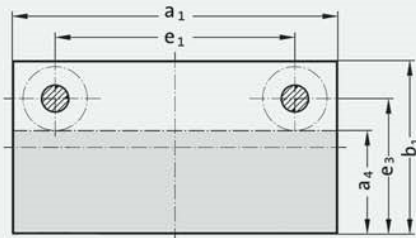

HL/2

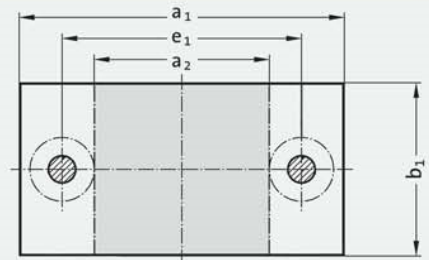

HL/3

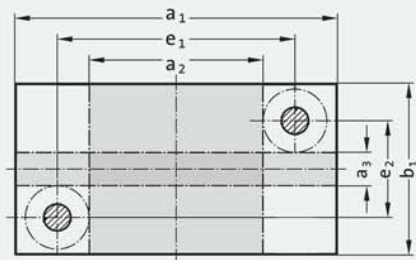

HL/4

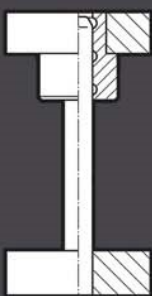
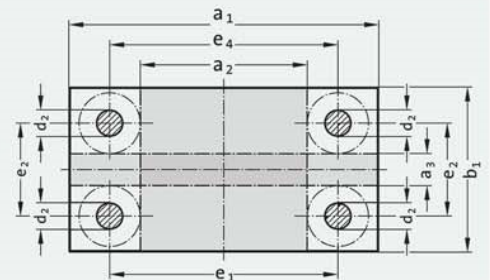

Slide Guide

راهنمای لغزشی

type A

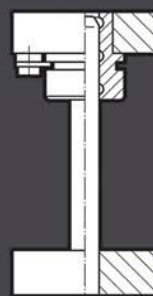

Demountable Bushes

بوش روبند دار
قابل دمونتاژ

type B

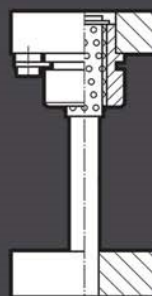

Ball Bearing Guide

راهنمای ساچمه ای

type C

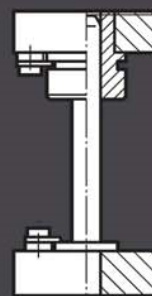

Demountable
Bushes and pillars

بوش و میل راهنمای
روبند دار (قابل دمونتاژ)

type D

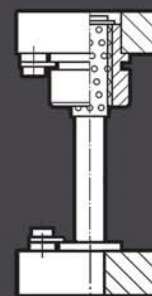

Demountable
Ball Bearing Guide

بوش و میل راهنمای
ساچمه ای روبند دار

type E



HL

Die Sets Without stripper

<i>a1 x b1</i>	<i>a2 x b1</i>	<i>a1 x a3</i>	<i>a1 x a4</i>	<i>C1_{±2}</i>	<i>C2_{±2}</i>	<i>c4</i>	<i>d1</i>	<i>d2</i>	<i>D</i>	<i>l</i>	<i>e1</i>	<i>e2</i>	<i>e3</i>
200 x 100	86 x 100	-	200 x 53	34	34	38	38	25	45	160	132	-	66
200 x 200	86 x 200	200 x 65	200 x 143	34	34	38	38	25	45	160	132	132	166
250 x 160	136 x 160	250 x 24	250 x 103	34	34	38	38	25	45	160	182	91	126
250 x 200	136 x 200	250 x 64	250 x 143	34	34	38	38	25	45	160	182	136	166
250 x 250	120 x 250	250 x 100	250 x 185	38	38	44	45	30	54	180	174	174	212
315 x 200	185 x 200	315 x 50	315 x 135	38	38	44	45	30	54	180	239	124	162
315 x 250	185 x 250	315 x 125	315 x 185	38	38	44	45	30	54	180	239	174	212
315 x 315	185 x 315	315 x 165	315 x 250	38	38	44	45	30	54	180	239	239	277
400 x 200	270 x 200	400 x 50	400 x 135	38	38	44	45	30	54	180	324	124	162
400 x 250	270 x 250	400 x 100	400 x 185	38	38	44	45	30	54	180	324	174	212
400 x 315	270 x 315	400 x 165	400 x 250	38	38	44	45	30	54	180	324	239	277
400 x 400	270 x 400	400 x 250	400 x 335	38	38	44	45	30	54	180	324	324	362
500 x 200	370 x 200	500 x 50	500 x 135	38	38	44	45	30	54	180	424	124	162
500 x 250	346 x 250	500 x 74	500 x 173	43	43	49	58	40	65	200	412	162	206
500 x 315	346 x 315	500 x 139	500 x 238	43	43	49	58	40	65	200	412	227	271
500 x 400	346 x 400	500 x 224	500 x 323	43	43	49	58	40	65	200	412	312	356
500 x 500	298 x 500	500 x 303	500 x 409	48	48	54	70	50	80	220	398	398	449
630 x 200	476 x 200	630 x 24	630 x 123	43	43	49	58	40	65	200	542	112	156
630 x 250	476 x 250	630 x 74	630 x 173	43	43	49	58	40	65	200	542	162	206
630 x 315	476 x 315	630 x 139	630 x 258	43	43	49	58	40	65	200	542	227	271
630 x 400	448x 400	630 x 201	630 x 309	48	48	54	70	50	80	220	528	298	349
630 x 500	448 x 500	630 x 301	630 x 409	48	48	54	70	50	80	220	528	398	449
710 x 315	528 x 315	710 x 116	710 x 224	48	48	54	70	50	80	220	608	213	264
710 x 400	528 x 400	710 x 201	710 x 309	48	48	54	70	50	80	220	608	298	349
710 x 500	528 x 500	710 x 301	710 x 409	48	48	54	70	50	80	220	608	398	449
800 x 315	618 x 315	800 x 116	800 x 224	48	48	54	70	50	80	220	698	213	264
800 x 400	618 x 400	800 x 201	800 x 309	48	48	54	70	50	80	220	698	298	349
800 x 500	618 x 500	800 x 301	800 x 409	48	48	54	70	50	80	220	698	398	449
800 x 630	618 x 630	800 x 431	800 x 539	48	48	54	70	50	80	220	698	528	579

Ordering code **HL** :

HL1 / 315 - 250 / C

كد محصول | Group No _____
 ابعاد خارجي | Ext. Dim _____
 نوع راسمما بندي | Guide system _____



SL

Die Sets Without stripper

ALL-STEEL DIE SET

Without Stripper

Plates Material : St37 , 1.1730 , 1.7225

SL/2

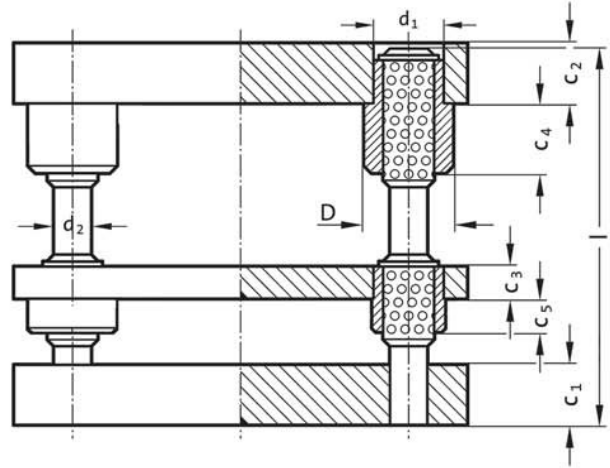
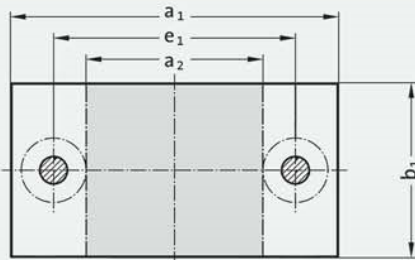

SL/3

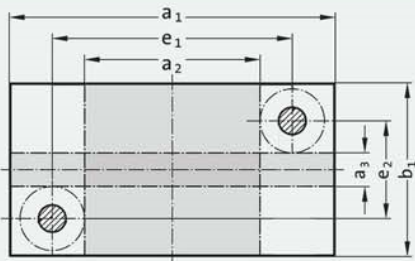

SL/4

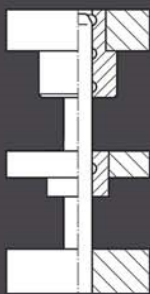
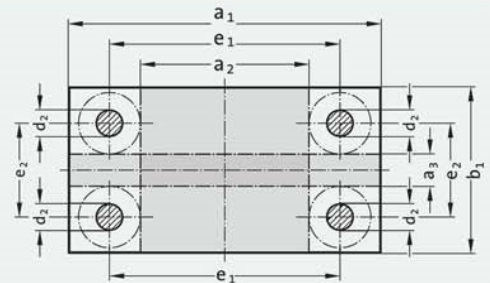

Slide Guide

راهنمای لغزشی

type A

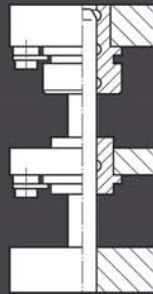

Demountable Bushes

بوش روبند دار
قابل دمونتاژ

type B

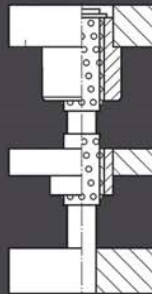

Ball Bearing Guide

راهنمای ساچمه ای

type C

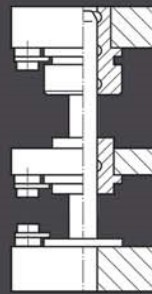

Demountable
Bushes and pillars

بوش و میل راهنمای
روبند دار (قابل دمونتاژ)

type D

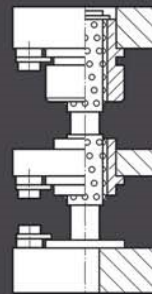

Demountable
Ball Bearing Guide

بوش و میل راهنمای
ساچمه ای روبند دار

type E



SL

Die Sets Without stripper

$a1 \times b1$	$a2 \times b1$	$a1 \times a3$	$C1_{+2}$	$C2_{+2}$	$C3_{+2}$	$C4$	$C5$	$d1$	$d2$	D	l	$e1$	$e2$
200 x 100	86 x 100	-	34	34	28	38	22	38	25	45	210	132	-
200 x 200	86 x 200	200 x 65	34	34	28	38	22	38	25	45	210	132	132
250 x 160	136 x 160	250 x 24	34	34	28	38	22	38	25	45	210	182	91
250 x 200	136 x 200	250 x 64	34	34	28	38	22	38	25	45	210	182	131
250 x 250	120 x 250	250 x 100	38	38	33	44	22	45	30	54	235	174	174
315 x 200	185 x 200	315 x 50	38	38	33	44	22	45	30	54	235	239	124
315 x 250	185 x 250	315 x 125	38	38	33	44	22	45	30	54	235	239	174
315 x 315	185 x 315	315 x 165	38	38	33	44	22	45	30	54	235	239	239
400 x 200	270 x 200	400 x 50	38	38	33	44	22	45	30	54	235	324	124
400 x 250	270 x 250	400 x 100	38	38	33	44	22	45	30	54	235	324	174
400 x 315	270 x 315	400 x 165	38	38	33	44	22	45	30	54	235	324	239
400 x 400	270 x 400	400 x 250	38	38	33	44	22	45	30	54	235	324	324
500 x 200	370 x 200	500 x 50	38	38	33	44	22	45	30	54	235	424	124
500 x 250	346 x 250	500 x 74	43	43	33	49	22	58	40	65	235	412	162
500 x 315	346 x 315	500 x 139	43	43	33	49	22	58	40	65	235	412	227
500 x 400	346 x 400	500 x 224	43	43	33	49	22	58	40	65	235	412	312
500 x 500	298 x 500	500 x 301	48	48	38	54	22	70	50	80	280	398	398
630 x 200	476 x 200	630 x 24	43	43	33	49	22	58	40	65	235	542	112
630 x 250	476 x 250	630 x 74	43	43	33	49	22	58	40	65	235	542	162
630 x 315	476 x 315	630 x 139	43	43	33	49	22	58	40	65	235	542	227
630 x 400	448x 400	630 x 201	48	48	38	54	22	70	50	80	280	528	298
630 x 500	448 x 500	630 x 301	48	48	38	54	22	70	50	80	280	528	398
710 x 315	528 x 315	710 x 116	48	48	38	54	22	70	50	80	280	608	213
710 x 400	528 x 400	710 x 201	48	48	38	54	22	70	50	80	280	608	298
710 x 500	528 x 500	710 x 301	48	48	38	54	22	70	50	80	280	608	398
800 x 315	618 x 315	800 x 116	48	48	38	54	22	70	50	80	280	698	213
800 x 400	618 x 400	800 x 201	48	48	38	54	22	70	50	80	280	698	298
800 x 500	618 x 500	800 x 301	48	48	38	54	22	70	50	80	280	698	398
800 x 630	618 x 630	800 x 431	48	48	38	54	22	70	50	80	280	698	528

Ordering code **SL** :

SL2 / 315 - 250 / A

کد محصول | Group No

ابعاد خارجی | Ext . Dim

نوع راهنما بندی | Guide system